

- BOD
- COD
- BTX
- TOC
- DOC
- UV254
- NO3
- NO2
- NH4
- K+
- Chlorine
- ClO2
- H2O2
- PAA
- F-
- TSS
- Turbidity
- Color
- pH
- ORP
- EC
- Temperature
- O2
- O3
- H2S
- AOC
- Fingerprints
- Contaminant Alarm

s::can
Intelligent. Optical. Online.

Water Quality OnLine Waste Water



Parameter & Product Overview

This is an overview of all the products and their respective parameters. Take a look at the parameters that you need to measure and choose the right product for your application. Further information can be found on the stated page number.

	max. Parameters*	BOD	COD	BTX	TOC	DOC	UV254	UV XXX (any specific wavelength)	NO ₃ -N	NO ₂ -N	TSS / TS	Turbidity	Color	Temperature	O ₃	HS- / H ₂ S	Fingerprint	Contaminant Alarm	NH ₄ -N	K+	F-	O ₂	pH	ORP	EC	Free / Total Chlorine	Page
spectro::lyser V3 (UV-Vis)	>8	■	■	■	■	■	■	■	■		■	■	■	■	■	■	■	■									18
spectro::lyser industrial	8	■	■	■	■	■	■	■	■		■	■	■	■	■	■	■	■									32
spectro::lyser titanium pro	8	■	■	■	■	■	■	■	■		■	■	■	■	■	■	■	■									34
spectro::lyser (UV)	8		■	■	■		■	■	■	■	□			■	■	■	■	■									30
carbo::lyser V3	4	■	■		■	■	■				■	■		■													22
nitro::lyser V3	2								■		■	■		■													26
multi::lyser V3	4	■	■		■	■	■		■		■	■		■													24
uv::lyser V3	3						■				■	■		■													28
i::scan	8		■				■				■		■	■													38
ammo::lyser	4								■					■					■	■				■			44
oxi::lyser	2													■								■					52
pH::lyser	2													■									■				54
redo::lyser	2													■										■			56
condu::lyser	2													■											■		58
soli::lyser	1										■																60
chlori::lyser	2																								■	-	-

* The number of parameters is depending on the specific configuration of the monitoring system.

Table of Contents

Who is s::can	3 – 6	Terminals	62 – 67
Foreword		con::cube V3 con::lyte eco/pro con::nect V3	
Parameter Overview	7 – 13	Software	68 – 77
Why do we measure How do we measure The s::can solution		moni::tool vali::tool ana::tool visu::tool moni::app	
Spectrometer Probes	14 – 35	System Configuration	78 – 81
spectro::lyser™ V3 carbo::lyser™ V3 multi::lyser™ V3 nitro::lyser™ V3 uv::lyser V3 spectro::lyser™ UV spectro::lyser™ industrial spectro::lyser™ titanium pro		con::cube con::lyte con::nect	
i::scan	36 – 39	Monitoring Stations	82 – 87
i::scan		micro::station	
Ionselective Probes	40 – 47	Spare Parts & Accessories	88 – 97
ammo::lyser™			
Physical Probes	48 – 61	Services & Solutions	98 – 101
oxi::lyser™ pH::lyser redo::lyser condu::lyser soli::lyser			



The s::can management team.
Pictured, from left:
Robert Wurm, CSO; Christoph Wagner, CIO;
Michael Steiner, General Manager;
Thomas Lederer, COO.

A warm welcome to s::can

You are holding in your hands the catalogue from s::can GmbH - the complete catalogue of online instruments for water quality monitoring. What makes this catalogue so special? The same thing that makes s::can special: s::can is the only firm in the world that has given its heart and soul to online water quality measurement. Since our foundation, nothing else has come out of our development department, nothing else has come out of our production sites, so now nothing else goes into our catalogue. We only ever become involved in technologies that are in line with this focus. This focus is unique in the world.

We are of the opinion that the time has come for reliable, simple, intelligent and inexpensive submersible probes for online water quality monitoring.

s::can GmbH

Founded in Vienna, Austria in 1999, since November 2020 part of Badger Meter, Inc., subsidiaries in the USA, France, Spain and Mexico, offices in China, Italy and Portugal.

Focus:

Research, development and production of innovative measuring instruments for online water quality monitoring.

Mission:

s::can offers a complete set of accurate, reliable, low-maintenance and inexpensive measuring instruments for comprehensive and time-resolved water quality monitoring. We consider online water quality monitoring the essential basis for the monitoring of any natural water bodies and for the economically and ecologically optimised operation of waste water treatment plants, drinking water works and industrial plants. Such monitoring and optimisation can help minimise the emission of pollution and hazardous substances into the environment thus helping to secure optimum water quality for human consumption at best possible economic efficiency.

s::can
Intelligent. Optical. Online.

Intelligent. Optical. OnLine.

Our Services & Our Guarantees

Whether it is a simple pH sensor or a complex spectral probe, s::can measuring instruments are intelligent and compatible with each other in s::can systems and with third-party systems. They can all communicate with all terminals, they can also be operated without a terminal and they can even be integrated directly into your control system without an extra terminal. They are always operated by the same software, viewed on the same display and installed, set up, calibrated and maintained in the same way. They have a comprehensive repertoire of self-diagnosis functions that are always executed automatically and they inform you immediately in plain language if deviations from optimum operation occur. All this is always done in the same way so that you only have to familiarise yourself once with the very intuitive s::can software and then you can operate all s::can instruments.

Optical

Organically developed, constantly tried and tested, and often proven: Optical works best. It doesn't matter whether it is COD, TOC, NO3, NO2, TSS, turbidity, dissolved oxygen, or many others besides. Whenever an optical method is available, we use it; when not, we develop one. Optical methods are the most reliable, the simplest, have the lowest cost, and, above all, they are usually the most accurate.

If ever a measurement is impossible by optical methods, then we just use the best alternative method that comes closest to our focus. For example, in our ammo::lyser™ the ammonium is measured using a combination of electrodes which is acknowledged as the best to date for a pH and potassium compensated ammonium measurement. With the ammo::lyser™, we have also set the standards, won in practically all tests against comparable instruments and ensured that the ammo::lyser™ is now regularly used in the biggest projects everywhere in the world.

OnLine & InSitu

We postponed the issue of this catalogue until our parameter range was complete, at least regarding typical applications in the areas of water, waste water, environmental monitoring, and industrial applications. We waited until we had developed an absolutely state of the art measuring instrument for each individual parameter. It is our firm conviction that each of those instruments cannot be bettered today in terms of performance, quality and cost. On top of this there are our fully modular compact measuring stations that combine these instruments into an organic whole. They present a complete solution whose modules the user has only to connect ("plug-and-measure") in order to receive at no extra cost a previously unheard of variety of immediately available information and parameters.

For instance the combination of the parameters COD-BOD-NO3-NH4-NO2-TSS-pH can be measured with only 2 s::can probes and 1 terminal, replacing an entire container of conventional cabinet analysers and thereby revolutionising water and waste water monitoring all around the world.

We are proud of having created all this in less than 10 years and also to have set new standards in water monitoring along the way. For example, in 2000 when we brought our first spectro::lyser™ to the market we established online UV spectrometry in sensor format in the marketplace years ahead of the competition. Today, with well over 10 000 systems sold, we are the undisputed global market leader in this segment and can continue to call ourselves the technological leader.

Our Services & Our Guarantees

About our prices

Have you ever been annoyed with a cheap printer that you just bought, only to find that the first time you had to change the ink cartridge it cost almost as much as the printer itself? Unfortunately a similar trend can be detected in the sector of water quality measurement technology - but not at s::can.

s::can does not try to make its profits from the sale of “consumables” such as reagents, consumable parts and the like, thereby hitting the customer with unexpected costs. s::can is not a “consumables company”. The consumables strategy contradicts our principles of fairness in the customer relationship and the importance we ascribe to running an ecologically sustainable business. Our business is simpler. We make our living from the sale of our measuring instruments. Most of our instruments are designed in such a way that they need no consumables at all and, if they do (e.g. with ISE probes), then they are designed in such a way that the use of consumables is in the region of the technically feasible minimum, and the consumables required can be purchased in the smallest possible units at the most keenly calculated prices. The advantage is obvious: The operating costs of our instruments are typically close to zero or a small fraction of that of our competitors. In terms of “total cost of ownership,” many of our instruments are already the best price to buy, and after 3 years or 5 years at the latest, all of our instruments are unrivalled economically. May we give you an estimated calculation for your application?

Cost Guarantee - No surprises over many years

Within the framework of individual service contracts and for an annual fee we will be happy to give you a guarantee to cover all costs that might arise in the operation of our instruments, beyond our comprehensive standard guarantees. For 3 years, 5 years or even 10 years. Whenever you compare our instruments with the instruments of other manufacturers, ask the other manufacturer to give you a guarantee to cover the operating costs over lengthy periods. You will be amazed how much less expensive s::can measuring instruments are to operate.

Quality Guarantee - No one can do more for optimum quality

The effort that we make in controlling quality in production is probably unique. Just visit us at our factory in Vienna, Austria, and we will be happy to show you our production plant and our QS system. As a result of our focus on allowing only reliable, simple and at the same time intelligent sensors be part of our measuring systems, we can give guarantees that were previously unheard of in our sector. For instance, we guarantee our optically operated sensors for up to 3 to 5 years. We give a minimum 2 year full guarantee on all other sensors – apart from consumables, but we can even cover those up to 100% within the Cost Guarantee.

“CleanData” Guarantee - And you can focus on your own job

Within service contracts we will also be happy to give functionality and availability guarantees. That extends to the “CleanData” concept. Here our local partners handle the installation, setup, calibration and maintenance of your instruments and we send you regular reports about the instruments’ performance, and can automatically give you service recommendations if you grant us remote access to the measuring system. Our “Support” department will even inform you about any special features of your application if that is what you want and is available to discuss the causes of any deviations. So you can keep your mind free of the measuring instrument, which is really a side issue for you, and dedicate yourself once more to your central tasks.

Environmental Guarantee - Monitoring the environment, not polluting it

Our measuring instruments are constructed so as not to use any chemicals or leave any waste. Most s::can instruments operate for many years without consuming any replacement or spare parts. Virtually no environmentally harmful processes or chemicals are used in manufacture. Every one of our instruments and also our entire range of instruments leaves a truly negligible “ecological footprint” compared with traditional laboratory, quick test and analyser technology.

Our services
+ Our guarantees

= your benefit

Water Quality Parameters

Correlation with laboratory parameters

It is an understandable requirement of users and also of monitoring bodies with legal duties to check the accuracy of measurement of online sensors compared to standardised reference methods in the laboratory. This check is indispensable – but often not trivial – in particular with measurements that are intended to check the compliance to emission limits.

The total error of measurement results from a) representativity of sample taken, compared to the online sensor, b) changes in the sample as a result of transportation and storage and, c) lab analysis errors, easily adding up to as much as 20% of the true value. This is for sure greatly depending on the parameter and application, but occurs even when the work is done most cleanly. The online measurement value is very often higher than the laboratory value since part of the target substance is often lost during handling. We have documented many examples where, despite the use of quality-controlled reference methods, parameters such as BOD, COD, NO₃-N, and TSS or TS were systematically 10 – 20% higher compared to laboratory measurements. These values were taken for calibration of the online sensor so as a result all the following measurements were too low by this percentage. Which might not be a major problem for process control, since all that matters there is good dynamics and stability, but is unacceptable for compliance monitoring. In our experience a correlation of 90% to 95% can normally be achieved between the online sensor and the laboratory, but just to achieve this takes a lot of specialist knowledge and experience, not least regarding sample taking and sample transportation. We are very happy to support our customers to achieve the best possible results with our comprehensive experience.

The pioneering (and currently world's only) international standard for assessing online measuring instruments for water quality monitoring is ISO 15839. We see this standard as a major step towards objective assessment of the quality of online water measurement instruments and we are already gradually moving to having all our instruments tested in this manner. As soon as approved research institutes are granted the authority to issue inspection certificates, we will show these in our specifications.

In recent years many countries have witnessed a change of paradigm towards the recognition of online methods and instruments often in acknowledgement of the tremendous operational advantages to be gained from continuously measuring dynamic values.

With more than 20 years of experience in the field of comparative studies, after over 100 technical commissionings and approvals, and with about a dozen tests always in progress in many countries of the world, s::can can offer you the best possible support in your comparative studies. We know what counts, even in the most varied applications that can occur in water management. Our feasibility studies and calibration reports are well known throughout the sector, are worked out meticulously and independently by the scientists in our “Support”-department using recognised methods, and turned out to be critical several times because of the commitment of this department to quality and objectivity without the pressure to sell.

Parameter Overview

“Why do we measure“

The goal of collecting and treating various waste waters is the reduction of the pollutant load released into natural waters that are used as receiving waters for the waste water. This task has to fulfil various guidelines that are defined in official emission and immission regulations.

A further goal is to keep the costs associated with waste water collection and treatment as low as possible. Because of the continuous efforts to improve the quality of natural waters and the permanent efforts to optimise the efficiency of waste water treatment, the requirements for process technology and for quality control of emissions are ever increasing. Therefore reliable monitoring stations that provide continuous data are an essential component in the waste water treatment - both for the dynamic process control as well as for continuous monitoring of the discharged water.

In management of municipal as well as industrial waste waters s::can monitoring stations have been in use for many years. Their technological and methodological quality standards have set new boundaries with regards to measurement performance and have often opened up completely new opportunities for wastewater treatment.

s::can

Intelligent. Optical. Online.

“How do we measure“

All s::can instruments can be operated according to the “plug & measure“ principle: With a simple plug connection, which provides power supply and data communication, the s::can sensors are connected to s::can terminals and are ready for use immediately. All s::can instruments are pre-calibrated ex works. The s::can terminals are equipped with the respective connectors (fully compatible interfaces) and the software for operation the s::can probes and sensors.

All s::can measurement systems consisting of standardised s::can products are ready for use without the need for complex initial procedures on site (no wiring, no long settings, no initial calibrations etc.). The “Plug & Measure“ principle avoids complex installation procedures on site and thus does not only save time during initial operation, but also reduces avoidable errors.

Manufactured using highly resistant materials and tested according to the highest quality standards, s::can measurement instruments can be used in practically all types of water. The highly optimised design completely eliminates all moving parts in contact with the water. This reduces failures and maintenance dramatically.

Using standardised mounting devices, s::can spectrometer probes can be installed quickly and effortlessly, either submersed (InSitu) or in a flow through setup (by-pass, monitoring station).

All s::can instruments are intelligent - amongst others local calibrations are stored on the instruments and auto-diagnosis procedures are used to ensure best possible operation.

Suitable for a wide range of applications, ranging from very low up to very high concentrations, from sum parameters to measurement of single substances, from ultra pure water to industrial waste waters, s::can monitoring systems provide reliable and accurate readings. Even in such applications, that had remained impossible for other instruments.

The s::can Solution

The spectrometer probe

Let's get out of the laboratory, and into the water. Away from the complicated and high-maintenance cabinet analysers towards reliable and simple online technologies and, above all, submersible spectrometers. A "mega trend" for the future of water management? We are convinced of it. s::can spectrometer probes need practically no maintenance, are extremely robust and durable and keep measuring for years, 24 hours a day, to the complete satisfaction of the operators. The advantages are obvious and are described later in more detail for the individual measurement parameters.

	Spectrometric	Photometric	Cabinet analyser
Accuracy	★★★	★	★★★★
Stability (drift)	★★★★	★★★	★★
Calibration effort	★★★	★★	★★★★
Maintenance effort	★★★★★	★★★★	★
Purchase costs	★★★★	★★★★	★
Operating costs	★★★★★	★★★★	★

Comparison of various procedures for monitoring organic chemistry

The spectrometer probe ...

... provides several crucial advantages over simple photometer probes:

- 1) A practically unlimited amount of parameters can be measured at once. This flexibility also permits expansion of the range of parameters for future applications which you are probably not thinking of at all today.
- 2) Measurement is incomparably more stable with regard to cross-sensitivities and therefore more accurate than photometer probes by entire orders of magnitude, especially in difficult applications.
- 3) Even in special applications, there is almost always a spectral range that correlates well with the substance of interest. In the event of major changes in water composition, only a new spectral calibration is required.
- 4) A large number of individual substances can also be identified against a fluctuating background matrix and separately quantified with the application of chemometric methods (e.g. BTX, phenols, solvents, flavouring agents etc.), which does not work at all with simple photometric probes.
- 5) Distinguishing between total and dissolved substances is possible: s::can uses a sophisticated mathematical algorithm that permits this distinction to be made reliably and usually works even without calibration.
- 6) The intelligent "spectral alarm" permits detection of deviations from a normal composition ("event detection") and provides an associated alarm signal. This method is now acknowledged and in use around the world, e.g. in drinking water and river water alarm systems and in industrial discharge monitoring.

Conventional Solutions

The traditional cabinet analyser

This type of instrument has been in use for about the last 30 years for measuring most chemical parameters. The advantage of such instruments was always with the manufacturers of consumables and not with the customers. These instruments can often be kept going only by means of comprehensive service contracts, they consume chemicals and spare parts, pollute the environment, and need considerable attention. Frequently they are so expensive and unreliable in operation that users just shut these instruments down again after some period of use.

The simple photometric probe

... despite its disadvantages, is still in widespread use today, probably because for a long time there simply was no better replacement available for monitoring organic carbon compounds (by correlation with the UV absorption signal at 254 nm). It is also used for monitoring nitrate (e.g. by correlation at 220 nm).

Since this probe can only ever measure one parameter, the optical filter would have to be changed to measure other substances, creating a great deal of work, and then the probe can in turn monitor only this one parameter: flexibility is very restricted. The measurement of COD can be rendered impossible simply by the discharge of a new industrial emitter into the sewage system.

However, with clear water and completely stable water composition, good results can sometimes be achieved. With fluctuations in turbidity, a second wavelength must also be measured for compensation, still this does not work nearly as well as full spectral compensation (see picture). This alone lifts these sensors up to the price level of s::can spectral instruments.

Since these probes remain restricted to single parameter monitoring, a substantial cost disadvantage compared with a spectral probe arises. These simple probes are just not able to cope with matrix fluctuations and they often provide results that are not sufficiently correlated with the true concentration values, or with the reference method.

The s::can Solution

s::can spectral instruments capture the major proportion of organic carbon compounds (because they are chemo-physically similar to UV oxidation in a TOC analyser), which as a general rule correlates excellently with the reference measurements. Recovery is estimated to be about 80% in domestic waste water. The correlation with other oxidative methods for TOC analysis is usually also good but, like all methods, it also has certain limits. Our experts can now almost always say from experience how good the expected correlation will be and help you with optimising the results.

The comparison between laboratory COD or laboratory TOC and spectrometrically determined values should always be better than 90% depending on the distribution of your reference samples. If that does not work out or is not satisfactory straight away, please contact s::can Support (email: support@s-can.at).

For many applications the distinction between total COD and dissolved COD, or between TOC and DOC is of major importance. This distinction is based on a physically consistent description of the solids by a spectral algorithm that has now been proven in practice thousands of times. (See diagram on the next page).

In addition here comes another great advantage of spectrometry: Not only can one quantify any change of the concentration of total organic compounds, expressed by COD or TOC, but it is also possible to identify several differentiated groups of organics or even detect individual organic substances that cause this change. It is even possible to distinguish between “normal” and “abnormal” (mostly undesirable) organic composition in “event detection systems”. The s::can spectrometer probe is now accepted by public authorities in many countries as a substitute measurement for COD or TOC, and this strong trend is continuing.

Spectral BOD as provided by s::can has nothing to do with the widely used simple correlation of BOD to UV254 that is used by other manufacturers but which seldom works reliably.

In principle it is not the respiration of the bacteria that is tracked - the standard measurement - but it is the easily digestible fraction of the organic compounds that is measured directly. To this end spectral algorithms were developed for various waters from thousands of samples, and these are based on the spectral integral of light absorption of biologically easily accessible chromophorous carbon compounds (e.g. proteins, acids etc.) in the wavelength range as pictured in the diagram on the next page.

It is always recommended that the BOD (as opposed to other spectral parameters) be calibrated on initialisation of a measuring station by comparison with a reference method.

The comparison between laboratory BOD and spectrally-determined online values should be better than 85%. If that is not sufficient or does not work straight away, just contact s::can Support and together we will achieve a still better correlation by supporting you with the reference measurements and/or conduct a calibration specifically for you.

Conventional Solutions

The traditional measurement of COD is conducted after pulping the sample with oxidants of varying strength (and varying harm to the environment) such as dichromate (about 90% recovery efficiency in domestic waste water) or manganese III (about 80% recovery efficiency in domestic waste water). In the attempt to come as close as possible to the normative standards, laboratory methods were transferred to field analysers and hardly changed. As these methods are not really practical in process and field applications, these analysers are as a rule expensive to buy and operate, complicated, unreliable and harmful to the environment, and often still do not conform to the legal standards. The quality of measurement actually achieved is then mostly well below the given specification since very few users have the time to invest in these instruments to keep them operating reliably. But even if these instruments worked perfectly, their availability and the accuracy achieved are still well below that of spectral probes since it is not easy to gain control of the incidental and systematic errors that occur because of their complexity.

It is not without reason that the replacement of COD cabinet analysers is one of s::can's major areas of business.

The disadvantages of TOC analysers occur in a similar area. In addition, depending on the method used, there is only ever a certain proportion of the organic carbon compounds that is oxidised and, as a result of the method, that fraction may well also be detected by the spectral probe as is the case with UV pulping which is popular due to being considered comparatively environmentally friendly.

Although BOD is a very interesting parameter, in particular for the modelling and layout of waste water treatment plants, it is difficult to sample, prepare and also to analyse. The main reason is clear. After all one is working here with living organisms that may behave quite differently depending on the water quality and experimental conditions thus a lot of scattering is introduced. BOD is normally measured by detecting the respiration of bacteria via oxygen content or indirectly via the gas pressure. Among other things, measurement in the low concentration range or in the presence of inhibitors regularly causes problems.

BOD cabinet analysers in particular do not reflect BOD according to the standard and they must therefore first be compared themselves with the “true” BOD method and calibrated accordingly. The maintenance effort may be considerable, which is why BOD is rarely measured online with any enthusiasm.

COD

**COD
dissolved**

TOC

BOD

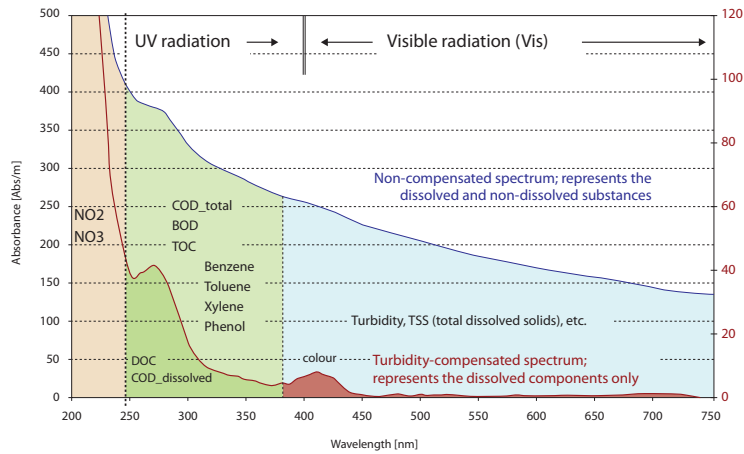

s::can measuring method – “Fingerprint“

The s::can Solution

NO₃-N Depending on the method, a spectral probe measures the nitrate concentration with much greater accuracy and stability and greater freedom from cross-sensitivities than a simple photometric probe (see diagram below). So an s::can spectral probe, regardless of whether it is a nitro::lyser™, multi::lyser™ or spectro::lyser™, is already widely used as a reference for simple photometric or ISE probes.

The nitrate value is accurately measured and displayed by s::can spectral probes in many applications without calibration. The detection limit in some applications is in the region of 0.005 mg/l (!) and even in a heavily loaded SBR reactor at 15 g/l TS, it is still better than 0.2 mg/l. The recommended measurement path length for the latter highly concentrated waste water is just 1 mm and, despite this, accurate measurements are possible, as is reliable cleaning of the measurement gap.

The nitrate value measured by s::can spectral probes is extremely stable in respect to matrix fluctuations. Thus, for instance, an accurate nitrate value can be measured with one and the same instrument in most flows without local calibration and this is not disturbed by typical daily, weekly or seasonal fluctuations either.

The higher purchase price compared with ISE probes will pay for itself in no more than one or two years of operation, and the many subsequent years of operation are characterised by problem-free, practically free-of-charge measurement, free of worries. You will soon no longer think about the nitro::lyser™ at all, while the measurement values, on the other hand, will become the basis of your day-to-day work which you take for granted.

Comparison of various methods for monitoring NO₃-N

	Spectrometric	Photometric	ISE
Accuracy	★★★★★	★★★	★★
Stability (drift)	★★★★★	★★★★	★
Calibration effort	★★★★★	★★★★	★
Maintenance effort	★★★★★	★★★★	★★★
Purchase costs	★★	★★★	★★★★
Operating costs	★★★★★	★★★★	★

Conventional Solutions

Nitrate is hardly ever measured these days with cabinet analysers since these also create disadvantages (hydraulic sampling, reagent consumption, maintenance effort etc.) and, in any case, recognised alternative methods exist.

Optical probes have been successful and have found acceptance globally, so today there is generally no longer any real reason to use a cabinet analyser for monitoring of nitrate.

Ion-selective (ISE) probes have also recently experienced a renaissance in nitrate measurement based on the lower purchase prices. However, by contrast with ammonium, the nitrate membranes available today are not so practical in use because they require more maintenance and are subject to more drift, re-calibration, and exchanges. In any event, today the ISE method is not suitable for WWTP compliance monitoring or even NO₃ monitoring in fresh waters because it is subject to strong drift especially visible at lower concentration levels. However, ISE probes are increasingly being offered as an alternative to control nutrient removal processes, often in combination with ammonium. The capital purchase price advantage compared with optical probes is striking only for a very short period. After just two years of operation the advantage is already lost because of the cost of consumables, and efforts required for calibration and electrode changing. After 10 years of operation, an ISE probe will have cost about two to three times as much in total as an optical probe, considering the total of maintenance hours and consumables.

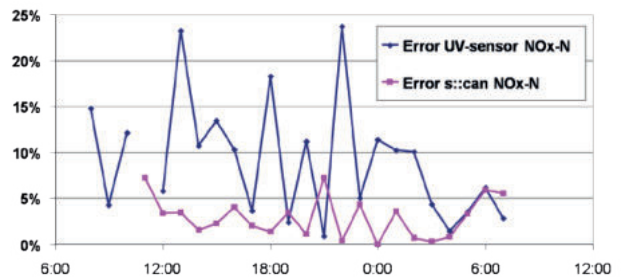

© s::can GmbH

The s::can Solution

s::can has achieved a breakthrough and can offer nitrite measurement, also in combination with nitrate and COD in a single probe, which correlates perfectly with the reference methods.

This opens up fundamentally new prospects both for treatment plant operators in their control and monitoring of nutrient removal, and for ecologists in their monitoring of the emission situation - NO₂-N is a poison dangerous to fish. The presence and fluctuation of nitrite concentration are always very informative indicators of disturbances to biological processes, i.e. presence of inhibitors.

For the first time, the combination of COD or TOC, nitrate and nitrite in a single probe for the operation and control of a treatment plant (see adjacent diagram) allows complete and detailed interpretation of the nutrient removal process.

The ammo::lyser™ is a third generation ion-selective (ISE) probe.

It is not just the concentration of NH₄-N in aqueous solution that is recorded but also the potassium concentration and the pH value thus allowing most interferences to be eliminated in a range of concentration of 0.1 to 1,000 mg/l. Optionally, a NO₃-N electrode can be added at elevated concentration levels of NO₃-N.

The expected effort and cost of installation, maintenance and consumables is considerably reduced with using the s::can ammo::lyser™, compared to cabinet analysers and investment costs are also lower by an entire order of magnitude.

With regard to the controller terminal, software, compressed air cleaning and interfaces, the ammo::lyser™ is fully integrated into s::can measuring systems, so it is simply connected to existing s::can systems and it can start measuring – the s::can “plug-and-measure” principle.

The ammo::lyser™ has several core distinguishing features compared with the ISE ammonium probes of other manufacturers:

Free of interference?

The ammo::lyser™ compensates fully for any interference with the ISE ammonium measurement. The superior features of the ammo::lyser™ are to be found in the use of the most highly-developed membranes and in the application of today's most advanced algorithms and calibration methods.

Conventional Solutions

Until recently nitrite was measured almost exclusively by laborious colorimetric methods using analyser cabinets. Here for example azo dye is added and measurement is done photometrically after the reaction. The disadvantages already mentioned (mechanical sampling, reagent consumption, maintenance effort, environmental pollution, costs etc.) in principle also apply to nitrite analysers. Because of this effort and expense the measurement of nitrite has not been widely used to date although many applications would benefit from the availability of this parameter.

NO₂-N

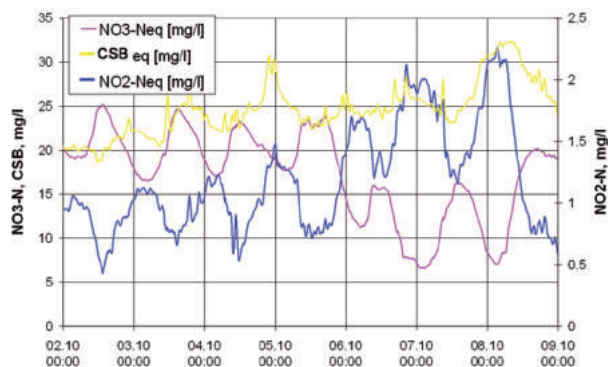

Ammonium is today still often measured with conventional cabinet analysers.

The disadvantages already mentioned (mechanical sampling, reagent consumption, maintenance effort, environmental pollution, costs etc.) in principle also apply to ammonium analysers.

NH₄-N

Here the potentiometric measurement principle is mostly used i.e. conversion into the gaseous phase as ammonia and measurement with a gas-sensitive NH₃ electrode. Lately, ammonium was also measured in the gaseous phase by the spectrometric method.

In both cases the conversion to the gaseous phase is achieved with effort, expense, uncertainty and some environmental pollution.

Following the great success of the s::can ammo::lyser™, users worldwide have once more found confidence in ISE technology. For example, in 2007 and 2011 more than 180 sewage works were fitted out in England alone. As a result, other manufacturers have recently produced other ISE probes which show similarities with the s::can ammo::lyser™ in some cases.

However you should test and compare the original s::can ammo::lyser™ so that you can judge its superiority for yourself. Contact your s::can sales partner to arrange a test!

The s::can Solution

Factory Calibration?

With the introduction of innovative calibration methods and new chemometric models as well as with the storage of all data and models “on board” the ammo::lyser™, previously unattainable precise and accurate measurements ex factory have become possible without initialising calibration.

Precise and accurate enough, even for compliance monitoring and fresh waters ?

The measurement performance of the ammo::lyser™ is unbeaten in all areas of applications, but in particular in applications with both low ammonium concentrations and high relative salt content with its potential for interference: this applies from nutrient removal control on WWTPs, compliance monitoring in WWTP effluents through to the monitoring of fresh water bodies . The s::can ammo::lyser™ has been able to come out ahead in all comparison tests to date – ask us for the details!

Cleaning/rinsing integrated?

Connect to the local compressed air source and it's done. The proven automatic compressed air cleaning is always integrated ex works.

Lowest operating costs?

The suggested infrequent exchange of individual membranes is easily possible with the s::can ammo::lyser™. In the aeration tank you normally only need to change the NH4 membrane once or twice a year. In WWTP effluents – for compliance monitoring - and in fresh waters the exchange might be wanted slightly more frequently.

The operating costs for the ammo::lyser™ are a fraction of those of other manufacturers since you can always exchange a single membrane and only when really needed.

Applications of s::can spectrometer probes from discharge to effluent

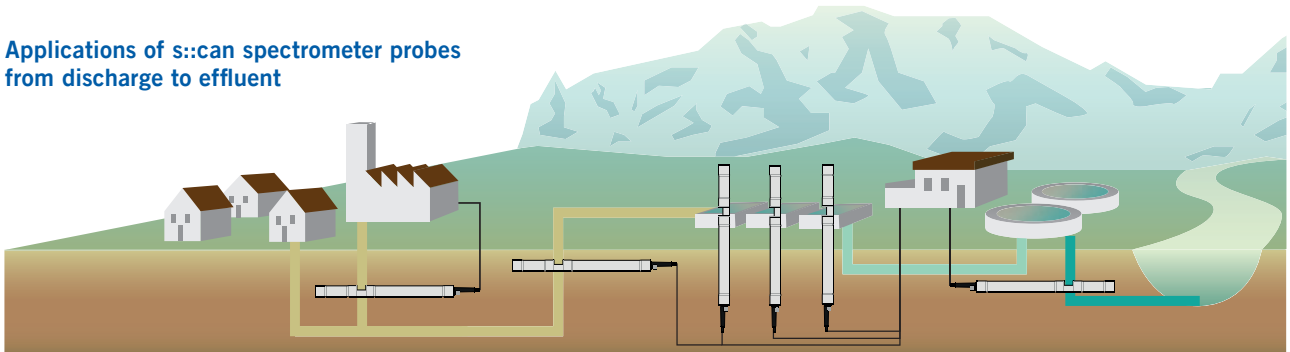

Monitoring of municipal and industrial waste water:

- Compliance with emission regulation limits
- Determination of process stability
- Determination of problems within/during the process
- Real time dosing
- Determination of product losses
- Effluent monitoring
- TSS
- COD
- NO3
- NH4
- pH
- EC
- ORP

Sewer Monitoring:

- Determination of waste water composition
- Identification of industrial dischargers
- TSS
- COD
- BOD
- NO3
- H2S
- Alarm
- NH4
- pH
- EC
- ORP
- O2

Monitoring of WWTP influent:

- Quantification of load and nutrients
- Judgement of consequences due to indirect dischargers
- Reaction to loadpeaks
- Real time dosing
- TSS
- COD
- BOD
- NO3
- H2S
- Alarm
- NH4
- pH
- EC
- ORP
- O2

Optimisation of aeration:

- Cost savings due to process optimisation
- Nitrification- and denitrification control in real time
- Reduction of operational costs
- TSS
- NO3
- NO2
- NH4
- TS
- O2
- ORP
- pH

Monitoring of WWTP effluent:

- Determination of efficiency
- Control of cleaning process
- Compliance with emission regulation limits
- TSS
- BOD
- NO3
- NO2
- NH4

Conventional Solutions

Most other ISE instruments on the market must be calibrated for initialisation or “adjusted to the medium” and this procedure has to be repeated significantly more often in operation than with the ammo::lyser™.

ISE instruments other than the ammo::lyser™ have to date not been successful in the difficult concentration range below 0.3 mg/l. Apart from probably the best membranes on the market we also offer you the experience with applications that is required to deal with this low concentration range, and to keep it stable over long periods of time.

Either an automatic cleaning device is not available at all or you have to pay extra for this important feature.

With other instruments on the market, once you have discovered that the membrane is worn out you have to replace the entire electrode each time or possibly even a cartridge containing all the electrodes. As a result the annual costs are several times those of the ammo::lyser™.

Our tip:

Ask your manufacturer to give you a guarantee for the operating costs over extended periods of time !

Spectrometer Probes



spectro::lyser with efficient automatic cleaning



spectro::lyser V3

Spectrometer Probes

“Why do we measure”

Usually sum parameters such as COD, COD filtered, BOD or SAC are established to quantify the organic load contaminating waste water because the total organics is composed of a multitude of substances.

scan spectro:lyser™ or carbo:lyser™ can continuously measure organic parameters as well as suspended solids in the influent allowing wastewater treatment plants preparing their process control according to the changing contaminant loads. This type of monitoring is essential as peaks in the organic load of the waste water can lead to troubles or even breakdowns of complete treatment processes. Used already in the sewer system the carbo:lyser™ provides a head start in detecting events and moreover can be employed to localise the origin of peaks in organics concentrations.

The separation of waste water treatment costs based on different pollutant loadings and the continuous monitoring for unexpected discharges into the sewer system are only two possible applications of the carbo:lyser™. As soon as the true concentrations of suspended solids and organic substances to be removed from the waste water are known, it is possible to optimise the design of sewers, reservoirs and treatment plants accordingly (most often the planned infrastructure can be reduced in size).

Although the presence of nitrate in untreated wastewater is often denied, using the nitro:lyser™ most often fluctuating nitrate levels in the waste water treatment plant influent have been observed - probably the result of water infiltration or industrial wastewater discharges.

The benefits of using a spectro:lyser™ or multi:lyser™ are even higher as they provide data of much greater information content: Two different fractions of the organics can be distinguished (for example COD and BOD) and simultaneously the concentrations of solids and nitrate can be determined using one single measurement instrument.

The typical application for the nitro:lyser™ in wastewater is in the biological treatment: In order to reduce the nutrient load of the water, at first nitrogen compounds are converted into nitrate. To achieve this nitrification, big amounts of oxygen have to be introduced into the wastewater. Subsequently, the formed nitrate is converted into nitrogen gas. Monitoring the nitrate concentration is a logical step to process control this biological nitrogen removal.

Nitrate plays a central role in both the energy and cost intensive nitrification and the de-nitrification. In addition to the nitrate level scan nitro:lyser™ probes also determine the concentration of solids and thus provide two important parameters for process control: TS and NO₃-N.

In the final effluent nitrate, COD and solids measurements enable analysis of the performance of the treatment (nitrogen and carbon removal). Furthermore, it allows real time detection of operational troubles and process interruptions of the wastewater treatment plant. The spectro:lyser™ can go one step further and even monitor nitrate and nitrite concentrations separately. This feature allows a more detailed management of the biological nitrogen removal, during the two major steps of which nitrite and nitrate are crucial intermediates.

Many industrial processes produce waste water that often can be discharged neither into the municipal sewers nor into natural waters without prior treatment. Commonly the discharger has to pay fees for discharging, the amount of which is determined by the contaminant load in the water. For this reason many dairies, breweries and paper mills use the spectro:lyser™ to monitor both the treatment performance and the compliance with discharge legislation. However, monitoring the parameters solids, COD and nitrate in the process effluent also provides an insight into the production processes themselves and thus allows to detect and to reduce losses of products and reagents.

The spectrum of applications of the spectro:lyser™ is completed by online measurements to detect untypical waste water compositions (for example probably toxic discharges using alarm), to reduce corrosion and odour problems (hydrogen sulphide) and to monitor specific substances in applications developed for individual customers (for example pesticide monitoring in process water).

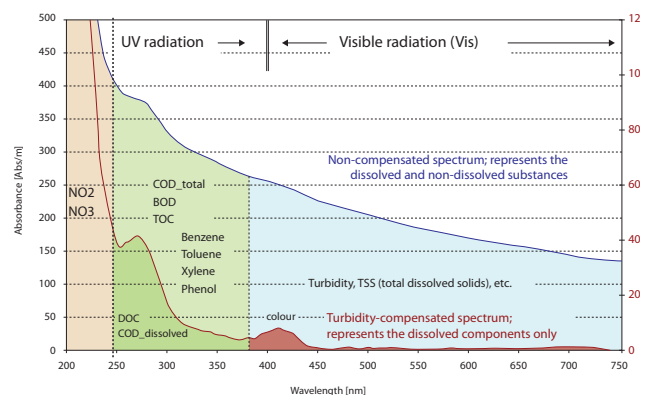

fig. 1 : “fingerprint” absorption spectra

Spectrometer Probes

“How do we measure”

All s::can spectrometer probes are multi-parameter instruments that can measure multiple water quality parameters continuously (OnLine) and directly in the water without the need for complex and maintenance intensive sample pre-treatment.

The most important versions of the spectrometer probe are the nitro::lyser™ (nitrate and turbidity/solids), the uv::lyser (UV254 and turbidity/solids), the carbo::lyser™ (COD/TOC/UV254/DOC and turbidity/solids), the multi::lyser™ (nitrate and COD/TOC/UV254/DOC and turbidity/solids) and the versatile spectro::lyser™ (nitrate, solids/turbidity, total and dissolved organics).

As all s::can instruments the spectrometer probes can be operated according to the “plug & measure” principle. With a simple plug connection, which provides power supply and data communication, the s::can sensors are connected to an s::can terminal and are ready for use. All s::can spectrometer probes are pre-calibrated ex works - specific Global Calibrations are available for a large number of standardised applications. The “Plug & Measure” principle avoids complex installation procedures on site and thus does not only save time during initial operation, but also reduces avoidable errors.

The highly optimised design completely eliminates all moving parts in contact with the water as well as consumables. This reduces failures, spare part costs and maintenance dramatically. For s::can spectrometer probes we guarantee replacement of spare parts free of charge for the first three years after delivery (upon presenting the warranty card).

Using standardised mounting devices s::can spectrometer probes can be installed quickly and effortlessly, either submersed (InSitu) or in a flow through setup (Bypass, monitoring station).

s::can spectrometer probes utilise an automatic cleaning system that uses compressed air for removal of fouling. This system has proven highly efficient and reliable, even in untreated wastewater. Because of this, regular manual cleaning of the optical windows is not required, thus significantly reducing maintenance for the operator.

Like all other s::can instruments the s::can spectrometer probes are intelligent instruments - using software controlled procedures it is even possible to identify any fouling on the measuring windows.

The s::can spectrometer instruments are fully capable spectrometers in the shape of a probe. In the measuring section, which is positioned between emitting and receiving units, the emitted light passes through the medium to be analysed. Substances present in the medium located in between the measuring windows of the probe adsorb visible and UV light. Internally a second light beam is guided across a comparison pathway. This two beam setup (see figure 2) makes it possible to compensate, with each single measurement, any instrumental effects that could influence the quality of the measurement (e.g. ageing of the light source).

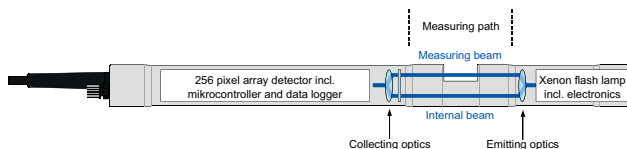

fig. 2: measuring path

s::can spectrometer probes record the complete absorbance spectrum between 190 and 720 nm (UV-Vis) or 190 - 390 nm (UV) resolving it into 256 wavelengths - the result is the “Fingerprint” (absorbance spectrum, see figure 1). Using the information contained in the fingerprint it is possible to monitor multiple parameters simultaneously and at the same time compensate these parameters for possible cross-sensitivities. The correlation with laboratory results reaches a quality that was unknown from the previously used simple optical instruments. Global Calibrations calculate the concentrations of multiple parameters from the Fingerprint and are available as application specific factory settings. Through the Global Calibrations each user benefits from many years of experience in applications similar to his own - in most cases no local calibration on site is required.

s::can spectrometer probes use no replaceable parts or consumables. Therefore, when operated properly there will be no costs for spare parts at all.

Its unrivalled measurement features in combination with the lowest possible total costs - initial cost and foreseeable operational costs - make the s::can spectrometer probe the most attractive solution available today.

spectro::lyser V3

spectro::lyser® UV-Vis monitors depending on the application an individual selection of: TSS, TS, turbidity, color, TOC, DOC, BOD, COD, NO₃-N, NO₃, HS-, O₃, CLD, UV254, fingerprints, spectral alarms and temperature

- measuring principle: UV-Vis spectrometry over the total range (190-750 nm)
- web server on board - IoT enabled, no user software is needed to configure the probe
- communicates directly with your mobile device via WLAN
- choose exactly the parameters you want to measure – unlimited number of parameters possible
- 8 GB onboard memory - capacity for logging data for many years
- improved optical performance - revolutionary precision
- fast measurement interval - every 10 seconds possible
- extremely power efficient - sleep mode for low energy consumption
- multiparameter probe with 1 mm, 5 mm or 35 mm optical path length, ideal for waste water, surface water and drinking water
- long term stable and maintenance free in operation
- factory precalibrated, local multi-point calibration possible
- automatic cleaning with compressed air or brush/ruck::sack

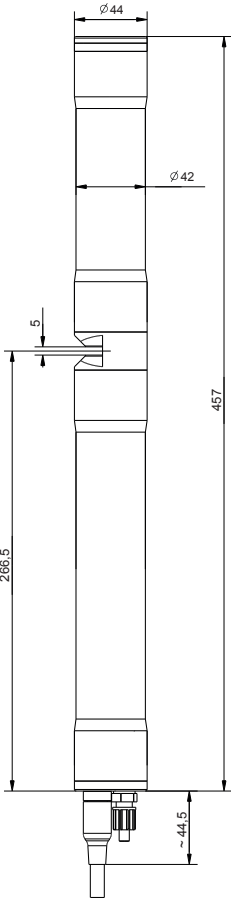

recommended accessories	
part number	article name
B-32-xxx	s::can compressor
B-33-012	con::nect V3
B-44	cleaning valve
B-44-2	
C-32-V3	Adapter cable to connect a V3 spectrometer (M12) to V2 Terminal (MIL Plug)
D-330-xxx	con::cube V3
F-110-V3	carrier s::can spectrometer V3 & V2 probe, 45°
F-48-V3	spectrometer V3 & V2 flow-cell (bypass setup), PVC
S-11-xx-moni	moni::tool Software

technical specification

measuring principle	UV-Vis spectrometry 190 - 750 nm
measuring principle detail	xenon flash lamp, pixel array detector
measurement interval	10 sec (configurable, depending on application)
automatic compensation instrument	real dual beam measurement for compensation and detailed diagnostics
automatic compensation cross sensitivities	turbidity / solids / organic substances
precalibrated ex-works	all parameters
accuracy standard solution (>1 mg/l)	NO ₃ -N: +/- 2% +1/OPL[mg/l]* COD-KHP: +/-2% +10/OPL[mg/l]* (* OPL ... optical pathlength in mm)
access to raw signals	access to spectral information
reference standard	distilled water
onboard memory	8 GB
integrated temperature sensor	0 ... 45 °C
resolution temperature sensor	0.1 °C
integration via	con::cube V3 con::nect V3 con::lyte V5 (D-320-pro2) and adapter cable (C-32-V3)
power supply	10 ... 18 VDC
power consumption (typical)	3 W
power consumption (sleep model)	60 mW
power consumption (max.)	20 W
interface to s::can terminals	M12 RSTS 8Y (IP67), RS485, Ethernet
interface to third party terminals	con::nect V3 incl. Modbus RTU, REST API, Modbus TCP/IP
digital interface (for cleaning devices)	1 digital in/out 1 digital out
network connection	100Base-T Ethernet, WLAN
status information	RGB LED ring

internal sensors	supply voltage sensor, tilt sensor, rotation sensor
cable length	1 m fixed cable (-010) or 7.5 m fixed cable (-075) or 15 m fixed cable (-150)
cable type	PU jacket
housing material	stainless steel 1.4404
window material	optical path length 5 and 1 mm: sapphire optical path length 35 mm: fused silica (UV-grade)
weight (min.)	3.4 kg (incl. cable)
dimensions (Ø x l)	optical path length 35 mm: 44 x 473 mm / 517.5 mm optical path length 5 mm: 44 x 457 mm / 501.5 mm optical path length 1 mm: 44 x 453 mm / 497.5 mm
operating temperature	0 ... 45 °C
operating pressure	0 ... 3 bar
high pressure specification (optional)	10 bar
installation / mounting	submersed or in a flow cell
flow velocity	3 m/s (max.)
mechanical stability	30 Nm
ingress protection class	IP68
automatic cleaning	media: compressed air or autobrush permissible pressure: 3 ... 6 bar
storage temperature	-10 ... 65 °C
conformity - environmental testing	EN 60721-3
conformity - EMC	EN 61326-1
conformity - RoHS 2	EN 50581
standard warranty	2 years
extended warranty (optional)	3 years

Spectrometer Probes

:::scan

lonselective Probes

Physical Probes

Terminals

Software

System Configuration

Monitoring Stations

Spare Parts & Accessories

Services & Solutions

The perfect accuracy for every application

The spectro::lyser V3 is available with three different optical path lengths.



drinking water:
35 mm

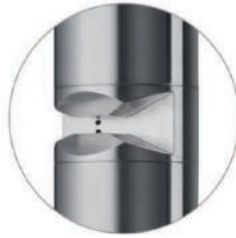

surface water:
5 mm



waste water:
1 mm

Optical information ring

The color of the optical information ring signals the state of the sensor.



everything
okay



sensor in
service mode

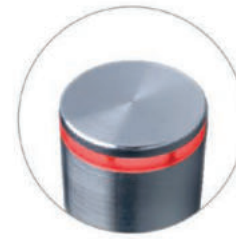

parameter or device
error

Wireless communication - Io::Tool

Intuitive web interface for data visualization and configuration of the spectro::lyser V3.



municipal WWTP influent & sewer															
		parameter													
		TSS [mg/l]	color (app) [Hazen]	color (tru) [Hazen]	TOC [mg/l]	DOC [mg/l]	BOD [mg/l]	COD [mg/l]	COD f [mg/l]	NO ₃ -N [mg/l]	HS- [mg/l]	UV254 [Abs/m]	UV254 f [Abs/m]	part number	
spectro::lyser™ V3 (1 mm OPL, UV-Vis)	min.	0	0	0	0	0	0	0	0	0	0	0	0	SP3-1-01-NO-xxx	
	max.	8000	23000	14000	3300	2600	5300	10000	5300	100	80	3300	2800		
spectro::lyser™ V3 (5 mm OPL, UV-Vis)	min.	0	0	0	0	0	0	0	0	0	0	0	0	SP3-1-05-NO-xxx	
	max.	1200	3500	2100	500	400	800	1500	800	16	12	500	420		

municipal WWTP aeration								
		parameter						
		TS [g/l]	COD f [mg/l]	NO ₃ -N [mg/l]	UV254 [Abs/m]	UV254 f [Abs/m]	part number	
spectro::lyser™ V3 (1 mm OPL, UV-Vis)	min.	0	0	0	0	0	SP3-1-01-NO-xxx	
	max.	20	530	26	3300	2800		

municipal WWTP effluent															
		parameter													
		TSS [mg/l]	turbidity [NTU/FTU]	color (app) [Hazen]	color (tru) [Hazen]	TOC [mg/l]	DOC [mg/l]	BOD [mg/l]	COD [mg/l]	COD f [mg/l]	NO ₃ -N [mg/l]	O ₃ [mg/l]	UV254 [Abs/m]	UV254 f [Abs/m]	part number
spectro::lyser™ V3 (1 mm OPL, UV-Vis)	min.	0	0	0	0	0	0	0	0	0	0	0	0	0	SP3-1-01-NO-xxx
	max.	4000	8000	23000	14000	2600	2000	2000	3300	2000	300	1200	3300	2800	
spectro::lyser™ V3 (5 mm OPL, UV-Vis)	min.	0	0	0	0	0	0	0	0	0	0	0	0	0	SP3-1-05-NO-xxx
	max.	600	1200	3500	2100	400	300	300	500	300	45	180	500	420	

paper mill WWTP influent									
		parameter							
		TSS [mg/l]	COD [mg/l]	COD f [mg/l]	NO ₃ -N [mg/l]	UV254 [Abs/m]	UV254 f [Abs/m]	part number	
spectro::lyser™ V3 (1 mm OPL, UV-Vis)	min.	0	0	0	0	0	0	SP3-1-01-NO-xxx	
	max.	8000	13000	11000	100	3300	2800		
spectro::lyser™ V3 (5 mm OPL, UV-Vis)	min.	0	0	0	0	0	0	SP3-1-05-NO-xxx	
	max.	1200	2000	1700	16	500	420		

paper mill WWTP effluent								
		parameter						
		TSS [mg/l]	COD [mg/l]	COD f [mg/l]	NO ₃ -N [mg/l]	UV254 [Abs/m]	UV254 f [Abs/m]	part number
spectro::lyser™ V3 (1 mm OPL, UV-Vis)	min.	0	0	0	0	0	0	SP3-1-01-NO-xxx
	max.	4000	5300	3300	100	3300	2800	
spectro::lyser™ V3 (5 mm OPL, UV-Vis)	min.	0	0	0	0	0	0	SP3-1-05-NO-xxx
	max.	600	790	490	16	500	420	

brewery WWTP influent								
		parameter						
		TSS [mg/l]	COD [mg/l]	COD f [mg/l]	NO ₃ -N [mg/l]	UV254 [Abs/m]	UV254 f [Abs/m]	part number
spectro::lyser™ V3 (1 mm OPL, UV-Vis)	min.	0	0	0	0	0	0	SP3-1-01-NO-xxx
	max.	13000	60000	53000	100	3300	2800	
spectro::lyser™ V3 (5 mm OPL, UV-Vis)	min.	0	0	0	0	0	0	SP3-1-05-NO-xxx
	max.	2000	9000	7900	16	500	420	

dairy WWTP influent								
		parameter						
		TSS [mg/l]	COD [mg/l]	COD f [mg/l]	NO ₃ -N [mg/l]	UV254 [Abs/m]	UV254 f [Abs/m]	part number
spectro::lyser™ V3 (1 mm OPL, UV-Vis)	min.	0	0	0	0	0	0	SP3-1-01-NO-xxx
	max.	8000	33000	16000	210	3300	2800	

carbo::lyser™ II / III - V3

carbo::lyser™ II monitors 2 of the following parameters: TSS, TS, TOC, DOC, BOD, COD, COD f, UV254 and UV254 f

carbo::lyser™ III monitors 3 of the following parameters: TSS, TOC, DOC, BOD, COD, COD f, UV254 and UV254 f

- measuring principle: UV-Vis spectrometry over the total range (190-750 nm)
- web server on board - IoT enabled, no user software is needed to configure the probe
- communicates directly with your mobile device via WLAN
- 8 GB onboard memory - capacity for logging data for many years
- improved optical performance - revolutionary precision
- fast measurement interval - every 10 seconds possible
- extremely power efficient - sleep mode for low energy consumption
- multiparameter probe with 1 mm, 5 mm or 35 mm optical path length, ideal for waste water, surface water and drinking water
- long term stable and maintenance free in operation
- factory precalibrated, local multi-point calibration possible
- automatic cleaning with compressed air or brush

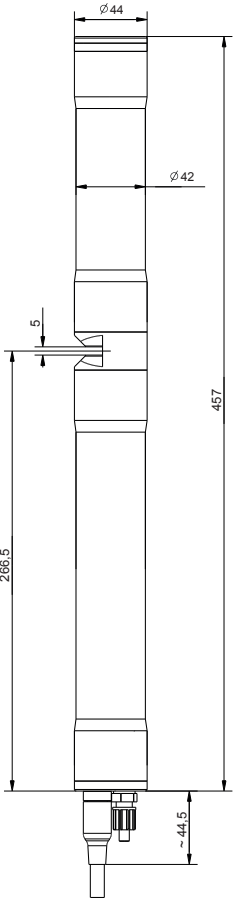

recommended accessories	
part number	article name
B-32-xxx	s::can compressor
B-33-012	con::nect V3
B-44	cleaning valve
B-44-2	
C-32-V3	Adapter cable to connect a V3 spectrometer (M12) to V2 Terminal (MIL Plug)
D-330-xxx	con::cube V3
F-110-V3	carrier s::can spectrometer V3 & V2 probe, 45°
F-120-V3	carrier s::can spectrometer V3 & V2 probe, vertical attachment
F-48-V3	spectrometer V3 & V2 flow-cell (bypass setup), PVC
S-11-xx-moni	moni::tool Software

technical specification			
measuring principle	UV-Vis spectrometry 190 - 750 nm	cable length	1 m fixed cable (-010) or 7.5 m fixed cable (-075) or 15 m fixed cable (-150)
measurement interval	10 sec (configurable, depending on application)	cable type	PU jacket
automatic compensation cross sensitivities	turbidity / solids / organic substances	housing material	stainless steel 1.4404
precalibrated ex-works	all parameters	window material	optical path length 5 and 1 mm: sapphire optical path length 35 mm: fused silica (UV-grade)
accuracy standard solution (>1 mg/l)	NO ₃ -N: +/- 3% +1/OPL[mg/l]* COD-KHP: +/-3% +10/OPL[mg/l]* (* OPL ... optical pathlength in mm)	weight (min.)	3.4 kg (incl. cable)
access to raw signals	no	dimensions (Ø x l)	optical path length 35 mm: 44 x 473 mm / 517.5 mm optical path length 5 mm: 44 x 457 mm / 501.5 mm optical path length 1 mm: 44 x 453 mm / 497.5 mm
reference standard	distilled water	operating temperature	0 ... 45 °C
onboard memory	8 GB	operating pressure	0 ... 3 bar
integrated temperature sensor	0 ... 45 °C	high pressure specification (optional)	10 bar
resolution temperature sensor	0.1 °C	installation / mounting	submersed or in a flow cell
integration via	con::cube V3 con::nect V3 con::lyte V5 (D-320-pro2) and adapter cable (C-32-V3)	flow velocity	3 m/s (max.)
power supply	10 ... 18 VDC	mechanical stability	30 Nm
power consumption (typical)	3 W	ingress protection class	IP68
power consumption (sleep model)	60 mW	automatic cleaning	media: compressed air or autobrush permissible pressure: 3 ... 6 bar
power consumption (max.)	20 W	storage temperature	-10 ... 65 °C
interface to s::can terminals	M12 RSTS 8Y (IP67), RS485, Ethernet	conformity - environmental testing	EN 60721-3
interface to third party terminals	con::nect V3 incl. Modbus RTU, REST API, Modbus TCP/IP	conformity - EMC	EN 61326-1
digital interface (for cleaning devices)	1 digital in/out 1 digital out	conformity - RoHS 2	EN 50581
network connection	100Base-T Ethernet, WLAN	standard warranty	2 years
status information	RGB LED ring	extended warranty (optional)	3 years
internal sensors	supply voltage sensor, tilt sensor, rotation sensor		

municipal WWTP influent & sewer

		parameter								part number
		TSS [mg/l]	TOC [mg/l]	DOC [mg/l]	BOD [mg/l]	COD [mg/l]	COD f [mg/l]	UV254 [Abs/m]	UV254 f [Abs/m]	
carbo::lyser™ II (2 parameters, 1 mm OPL)	min.	0	0	0	0	0	0	0	0	G3-C2-I-01-NO-xxx
	max.	8000	3300	2600	5300	10000	5300	3300	2800	
carbo::lyser™ II (2 parameters, 5 mm OPL)	min.	0	0	0	0	0	0	0	0	G3-C2-I-05-NO-xxx
	max.	1200	500	400	800	1500	800	500	420	
carbo::lyser™ III (3 parameters, 1mm OPL)	min.	0	0	0	0	0	0	0	0	G3-C3-I-01-NO-xxx
	max.	8000	3300	2300	5300	10000	5300	3300	2800	
carbo::lyser™ III (3 parameters, 5 mm OPL)	min.	0	0	0	0	0	0	0	0	G3-C3-I-05-NO-xxx
	max.	1200	500	400	800	1500	800	500	420	

municipal WWTP effluent

		parameter								part number
		TSS [mg/l]	TOC [mg/l]	DOC [mg/l]	BOD [mg/l]	COD [mg/l]	COD f [mg/l]	UV254 [Abs/m]	UV254 f [Abs/m]	
carbo::lyser™ II (2 parameters, 5 mm OPL)	min.	0	0	0	0	0	0	0	0	G3-C2-E-05-NO-xxx
	max.	600	400	300	300	500	300	500	420	
carbo::lyser™ III (3 parameters, 5 mm OPL)	min.	0	0	0	0	0	0	0	0	G3-C3-E-05-NO-xxx
	max.	600	400	300	300	500	300	500	420	

multi:lyser™ IV - V3

multi:lyser™ IV monitors 4 of the following parameters: TSS, TS, TOC, DOC, BOD, COD, COD f, NO3-N, UV254 and UV254 f

- measuring principle: UV-Vis spectrometry over the total range (190-750 nm)
- web server on board - IoT enabled, no user software is needed to configure the probe
- communicates directly with your mobile device via WLAN
- 8 GB onboard memory - capacity for logging data for many years
- improved optical performance - revolutionary precision
- fast measurement interval - every 10 seconds possible
- extremely power efficient - sleep mode for low energy consumption
- multiparameter probe with 1 mm, 5 mm or 35 mm optical path length, ideal for waste water, surface water and drinking water
- long term stable and maintenance free in operation
- factory precalibrated, local multi-point calibration possible
- automatic cleaning with compressed air or brush

recommended accessories

part number	article name
B-32-xxx	s:can compressor
B-33-012	con::nect V3
B-44	cleaning valve
B-44-2	
C-32-V3	Adapter cable to connect a V3 spectrometer (M12) to V2 Terminal (MIL Plug)
D-330-xxx	con::cube V3
F-110-V3	carrier s:can spectrometer V3 & V2 probe, 45°
F-120-V3	carrier s:can spectrometer V3 & V2 probe, vertical attachment
F-48-V3	spectrometer V3 & V2 flow-cell (bypass setup), PVC
S-11-xx-moni	moni::tool Software

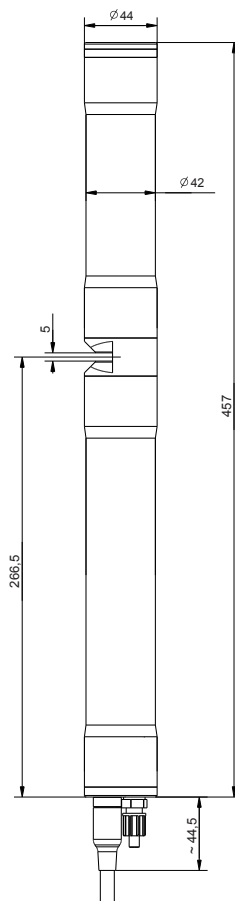

technical specification	
measuring principle	UV-Vis spectrometry 190 - 750 nm
measurement interval	10 sec (configurable, depending on application)
automatic compensation cross sensitivities	turbidity / solids / organic substances
precalibrated ex-works	all parameters
accuracy standard solution (>1 mg/l)	NO ₃ -N: +/- 3% +1/OPL[mg/l]* COD-KHP: +/-3% +10/OPL[mg/l]* (* OPL ... optical pathlength in mm)
access to raw signals	no
reference standard	distilled water
onboard memory	8 GB
integrated temperature sensor	0 ... 45 °C
resolution temperature sensor	0.1 °C
integration via	con::cube V3 con::nect V3 con::lyte V5 (D-320-pro2) and adapter cable (C-32-V3)
power supply	10 ... 18 VDC
power consumption (typical)	3 W
power consumption (sleep model)	60 mW
power consumption (max.)	20 W
interface to s::can terminals	M12 RSTS 8Y (IP67), RS485, Ethernet
interface to third party terminals	con::nect V3 incl. Modbus RTU, REST API, Modbus TCP/IP
digital interface (for cleaning devices)	1 digital in/out 1 digital out
network connection	100Base-T Ethernet, WLAN
status information	RGB LED ring
internal sensors	supply voltage sensor, tilt sensor, rotation sensor
cable length	1 m fixed cable (-010) or 7.5 m fixed cable (-075) or 15 m fixed cable (-150)
cable type	PU jacket
housing material	stainless steel 1.4404
window material	optical path length 5 and 1 mm: sapphire optical path length 35 mm: fused silica (UV-grade)
weight (min.)	3.4 kg (incl. cable)
dimensions (Ø x l)	optical path length 35 mm: 44 x 473 mm / 517.5 mm optical path length 5 mm: 44 x 457 mm / 501.5 mm optical path length 1 mm: 44 x 453 mm / 497.5 mm
operating temperature	0 ... 45 °C
operating pressure	0 ... 3 bar
high pressure specification (optional)	10 bar
installation / mounting	submersed or in a flow cell
flow velocity	3 m/s (max.)
mechanical stability	30 Nm
ingress protection class	IP68
automatic cleaning	media: compressed air or autobrush permissible pressure: 3 ... 6 bar
storage temperature	-10 ... 65 °C
conformity - environmental testing	EN 60721-3
conformity - EMC	EN 61326-1
conformity - RoHS 2	EN 50581
standard warranty	2 years
extended warranty (optional)	3 years

municipal WWTP influent & sewer

		parameter										part number
		TSS [mg/l]	TOC [mg/l]	DOC [mg/l]	BOD [mg/l]	COD [mg/l]	COD f [mg/l]	NO ₃ -N [mg/l]	NO ₃ [mg/l]	UV254 [Abs/m]	UV254 f [Abs/m]	
multi::lyser™ IV (4 parameters, 1 mm OPL)	min.	0	0	0	0	0	0	0	0	0	0	G3-M4-I-01-NO-xxx
	max.	8000	3300	2600	5300	10000	5300	100	460	3300	2800	
multi::lyser™ IV (4 parameters, 5 mm OPL)	min.	0	0	0	0	0	0	0	0	0	0	G3-M4-I-05-NO-xxx
	max.	1200	500	400	800	1500	800	16	70	500	420	

municipal WWTP aeration

		parameter				part number
		TS [g/l]	COD f [mg/l]	NO ₃ -N [mg/l]	NO ₃ [mg/l]	
multi::lyser™ IV (4 parameters, 1 mm OPL)	min.	0	0	0	0	G3-M4-A-01-NO-xxx
	max.	20	530	26	110	

municipal WWTP effluent

		parameter										part number
		TSS [mg/l]	TOC [mg/l]	DOC [mg/l]	BOD [mg/l]	COD [mg/l]	COD f [mg/l]	NO ₃ -N [mg/l]	NO ₃ [mg/l]	UV254 [Abs/m]	UV254 f [Abs/m]	
multi::lyser™ IV (4 parameters, 5 mm OPL)	min.	0	0	0	0	0	0	0	0	0	0	G3-M4-E-05-NO-xxx
	max.	600	400	300	300	500	300	45	190	500	420	

nitro::lyser™ II - V3

nitro::lyser™ II monitors 2 of the following parameters: TSS, TS, NO₃-N and NO₃

- measuring principle: UV-Vis spectrometry over the total range (190-750 nm)
- web server on board - IoT enabled, no user software is needed to configure the probe
- communicates directly with your mobile device WLAN
- 8 GB onboard memory - capacity for logging data for many years
- improved optical performance - revolutionary precision
- fast measurement interval - every 10 seconds possible
- extremely power efficient - sleep mode for low energy consumption
- multiparameter probe with 1 mm, 5 mm or 35 mm optical path length, ideal for waste water, surface water and drinking water
- long term stable and maintenance free in operation
- factory precalibrated, local multi-point calibration possible
- automatic cleaning with compressed air or brush

recommended accessories

part number	article name
B-32-xxx	s::can compressor
B-33-012	con::nect V3
B-44	cleaning valve
B-44-2	
C-32-V3	Adapter cable to connect a V3 spectrometer (M12) to V2 Terminal (MIL Plug)
D-330-xxx	con::cube V3
F-110-V3	carrier s::can spectrometer V3 & V2 probe, 45°
F-120-V3	carrier s::can spectrometer V3 & V2 probe, vertical attachment
F-48-V3	spectrometer V3 & V2 flow-cell (bypass setup), PVC
S-11-xx-moni	moni::tool Software

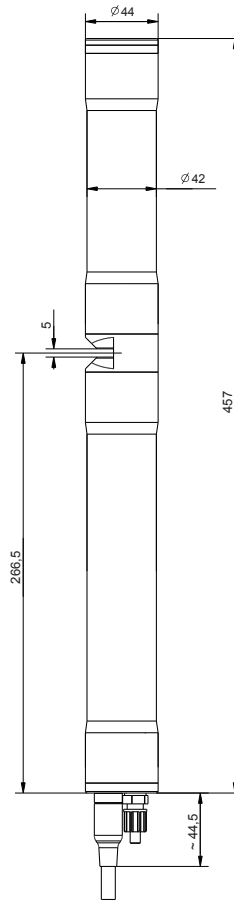

technical specification

measuring principle	UV-Vis spectrometry 190 - 750 nm	cable length	1 m fixed cable (-010) or 7.5 m fixed cable (-075) or 15 m fixed cable (-150)
measurement interval	10 sec (configurable, depending on application)	cable type	PU jacket
automatic compensation cross sensitivities	turbidity / solids / organic substances	housing material	stainless steel 1.4404
precalibrated ex-works	all parameters	window material	optical path length 5 and 1 mm: sapphire optical path length 35 mm: fused silica (UV-grade)
accuracy standard solution (>1 mg/l)	NO ₃ -N: +/- 3% +1/OPL[mg/l]* COD-KHP: +/-3% +10/OPL[mg/l]* (* OPL ... optical pathlength in mm)	weight (min.)	3.4 kg (incl. cable)
access to raw signals	no	dimensions (Ø x l)	optical path length 35 mm: 44 x 473 mm / 517.5 mm optical path length 5 mm: 44 x 457 mm / 501.5 mm optical path length 1 mm: 44 x 453 mm / 497.5 mm
reference standard	distilled water	operating temperature	0 ... 45 °C
onboard memory	8 GB	operating pressure	0 ... 3 bar
integrated temperature sensor	0 ... 45 °C	high pressure specification (optional)	10 bar
resolution temperature sensor	0.1 °C	installation / mounting	submersed or in a flow cell
integration via	con::cube V3 con::nect V3 con::lyte V5 (D-320-pro2) and adapter cable (C-32-V3)	flow velocity	3 m/s (max.)
power supply	10 ... 18 VDC	mechanical stability	30 Nm
power consumption (typical)	3 W	ingress protection class	IP68
power consumption (sleep model)	60 mW	automatic cleaning	media: compressed air or autobrush permissible pressure: 3 ... 6 bar
power consumption (max.)	20 W	storage temperature	-10 ... 65 °C
interface to s::can terminals	M12 RSTS 8Y (IP67), RS485, Ethernet	conformity - environmental testing	EN 60721-3
interface to third party terminals	con::nect V3 incl. Modbus RTU, REST API, Modbus TCP/IP	conformity - EMC	EN 61326-1
digital interface (for cleaning devices)	1 digital in/out 1 digital out	conformity - RoHS 2	EN 50581
status information	RGB LED ring	standard warranty	2 years
internal sensors	supply voltage sensor, tilt sensor, rotation sensor	extended warranty (optional)	3 years

municipal WWTP influent & sewer

		parameter			
		TSS [mg/l]	NO ₃ -N [mg/l]	NO ₃ [mg/l]	part number
nitro::lyser™ II (2 parameters, 1 mm OPL)	min.	0	0	0	G3-N2-I-01-NO-xxx
	max.	8000	100	460	
nitro::lyser™ II (2 parameters, 5 mm OPL)	min.	0	0	0	G3-N2-I-05-NO-xxx
	max.	1200	16	70	

municipal WWTP aeration

		parameter			
		TS [g/l]	NO ₃ -N [mg/l]	NO ₃ [mg/l]	part number
nitro::lyser™ II (2 parameters, 1 mm OPL)	min.	0	0	0	G3-N2-A-01-NO-xxx
	max.	20	26	110	

municipal WWTP effluent

		parameter			
		TSS [mg/l]	NO ₃ -N [mg/l]	NO ₃ [mg/l]	part number
nitro::lyser™ II (2 parameters, 5 mm OPL)	min.	0	0	0	G3-N2-E-05-NO-xxx
	max.	600	45	190	

uv::lyser V - V3

uv::lyser V monitors TSS and up to 4 freely selectable wavelngts

- measuring principle: UV-Vis spectrometry over the total range (190-750 nm)
- web server on board - IoT enabled, no user software is needed to configure the probe
- communicates directly with your mobile device via WLAN
- 8 GB onboard memory - capacity for logging data for many years
- improved optical performance - revolutionary precision
- fast measurement interval - every 10 seconds possible
- extremely power efficient - sleep mode for low energy consumption
- multiparameter probe with 1 mm, 5 mm or 35 mm optical path length, ideal for waste water, surface water and drinking water
- long term stable and maintenance free in operation
- factory precalibrated, local multi-point calibration possible
- automatic cleaning with compressed air or brush

recommended accessories

part number	article name
B-32-xxx	s::can compressor
B-33-012	con::nect V3
B-44	cleaning valve
B-44-2	
C-32-V3	Adapter cable to connect a V3 spectrometer (M12) to V2 Terminal (MIL Plug)
D-330-xxx	con::cube V3
F-110-V3	carrier s::can spectrometer V3 & V2 probe, 45°
F-120-V3	carrier s::can spectrometer V3 & V2 probe, vertical attachment
F-48-V3	spectrometer V3 & V2 flow-cell (bypass setup), PVC
S-11-xx-moni	moni::tool Software

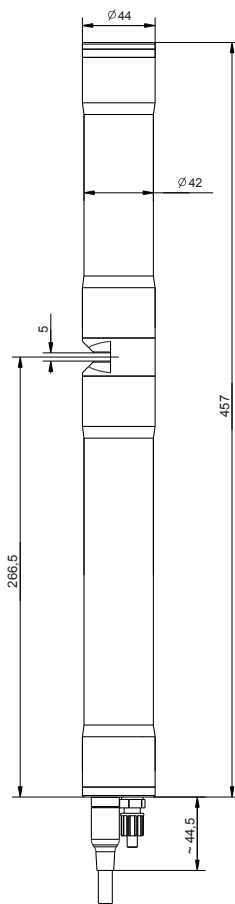

technical specification

measuring principle	UV-Vis spectrometry 190 - 750 nm	cable length	1 m fixed cable (-010) or 7.5 m fixed cable (-075) or 15 m fixed cable (-150)
measurement interval	10 sec (configurable, depending on application)	cable type	PU jacket
automatic compensation cross sensitivities	turbidity / solids / organic substances	housing material	stainless steel 1.4404
precalibrated ex-works	all parameters	window material	optical path length 5 and 1 mm: sapphire optical path length 35 mm: fused silica (UV-grade)
accuracy standard solution (>1 mg/l)	NO ₃ -N: +/- 3% +1/OPL[mg/l]* COD-KHP: +/-3% +10/OPL[mg/l]* (* OPL ... optical pathlength in mm)	weight (min.)	3.4 kg (incl. cable)
access to raw signals	no	dimensions (Ø x l)	optical path length 35 mm: 44 x 473 mm / 517.5 mm optical path length 5 mm: 44 x 457 mm / 501.5 mm optical path length 1 mm: 44 x 453 mm / 497.5 mm
reference standard	distilled water	operating temperature	0 ... 45 °C
onboard memory	8 GB	operating pressure	0 ... 3 bar
integrated temperature sensor	0 ... 45 °C	high pressure specification (optional)	10 bar
resolution temperature sensor	0.1 °C	installation / mounting	submersed or in a flow cell
integration via	con::cube V3 con::nect V3 con::lyte V5 (D-320-pro2) and adapter cable (C-32-V3)	flow velocity	3 m/s (max.)
power supply	10 ... 18 VDC	mechanical stability	30 Nm
power consumption (typical)	3 W	ingress protection class	IP68
power consumption (sleep model)	60 mW	automatic cleaning	media: compressed air or autobrush permissible pressure: 3 ... 6 bar
power consumption (max.)	20 W	storage temperature	-10 ... 65 °C
interface to s::can terminals	M12 RSTS 8Y (IP67), RS485, Ethernet	conformity - environmental testing	EN 60721-3
interface to third party terminals	con::nect V3 incl. Modbus RTU, REST API, Modbus TCP/IP	conformity - EMC	EN 61326-1
digital interface (for cleaning devices)	1 digital in/out 1 digital out	conformity - RoHS 2	EN 50581
network connection	100Base-T Ethernet, WLAN	standard warranty	2 years
status information	RGB LED ring	extended warranty (optional)	3 years
internal sensors	supply voltage sensor, tilt sensor, rotation sensor		

municipal WWTP influent & sewer

		parameter			
		TSS [mg/l]	UV254 [Abs/m]	UV254 f [Abs/m]	part number
uv::lyser V (5 parameters, 5 mm OPL)	min.	0	0	0	G3-U5-I-05-NO-xxx
	max.	1200	500	420	
uv::lyser V (5 parameters, 1 mm OPL)	min.	0	0	0	G3-U5-I-01-NO-xxx
	max.	8000	3300	2800	

municipal WWTP effluent

		parameter			
		TSS [mg/l]	UV254 [Abs/m]	UV254 f [Abs/m]	part number
uv::lyser V (5 parameters, 5 mm OPL)	min.	0	0	0	G3-U5-E-05-NO-xxx
	max.	600	500	420	

spectro::lyser™ (UV)

spectro::lyser™ UV monitors depending on the application an individual selection of: NO₂-N, TSS (est), turbidity (est) NO₃-N, COD, BOD, TOC, UV254, BTX, fingerprints and spectral alarms, temperature and pressure

- s:can plug & measure
- measuring principle: spectrometry over the UV range (190-390 nm)
- multiparameter probe with adjustable open path length
- ideal for surface water, ground water, drinking water and waste water
- long term stable and maintenance free in operation
- factory precalibrated, local multi-point calibration possible
- automatic cleaning with compressed air or brush
- mounting and measurement directly in the media (InSitu) or in a flow cell (monitoring station)
- operation via s:can terminals & s:can software
- cleaning integrated
- adaption of optical path lengths to 5 mm, 2 mm, 1 mm or 0.5 mm possible
- easy mounting without clogging

recommended accessories

part number	article name
A-500-s	Inserts for optical pathlength 0.5 mm, stainless steel
A-001-s	Inserts for optical pathlength 1 mm, stainless steel
A-002-s	Inserts for optical pathlength 2 mm, stainless steel
A-005-s	Inserts for optical pathlength 5 mm, stainless steel
A-015-s	Inserts for optical pathlength 15 mm, stainless steel
B-32-xxx	s:can compressor
D-330-xxx	con::cube V3
F-120-V3	carrier s:can spectrometer V3 & V2 probe, vertical attachment
F-48-V3	spectrometer V3 & V2 flow-cell (bypass setup), PVC
S-11-xx-moni	moni::tool Software

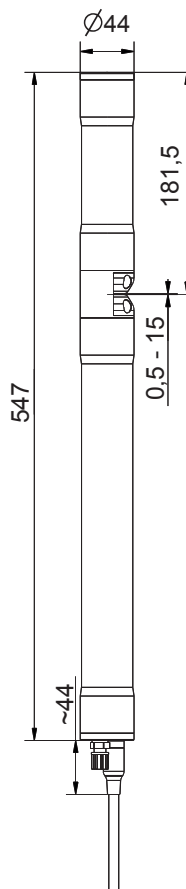

technical specification

measuring principle	UV spectrometry 190 - 390 nm	window material	optical path length 15 ... 0.5 mm: sapphire optional: optical path length 100 ... 5 mm: fused silica (UV-grade)
measuring principle detail	xenon flash lamp, 256 photo diodes	weight (min.)	3.4 kg (incl. cable)
automatic compensation instrument	two beam measurement, complete spectrum	dimensions (Ø x l)	optical path length 100 mm: 44 x 612 mm / 656 mm optical path length 35 ... 0.5 mm: 44 x 547 mm / 591 mm
automatic compensation cross sensitivities	turbidity / solids / organic substances	operating temperature	0 ... 45 °C
precalibrated ex-works	all parameters	operating pressure	0 ... 5 bar
accuracy standard solution (>1 mg/l)	NO ₃ -N: +/- 2% +1/OPL[mg/l]* COD-KHP: +/-2% +10/OPL[mg/l]* (* OPL ... optical pathlength in mm)	high pressure specification (optional)	10 bar
access to raw signals	access to spectral information	explosion proof specification (optional)	RL 2014/34/EU, TÜV-A16 ATEX 3001Q ATEX Marking: II 2 G Ex db IIC T6 Gb
reference standard	distilled water	installation / mounting	submersed or in a flow cell
onboard memory	656 KB	flow velocity	3 m/s (max.)
integrated temperature sensor	-10 ... 50 °C	mechanical stability	30 Nm
resolution temperature sensor	0.1 °C	ingress protection class	IP68
integrated pressure sensor (optional)	0 ... 1.2/2/11 bar	automatic cleaning	media: compressed air or autobrush permissible pressure: 3 ... 6 bar
resolution pressure sensor	1:1000 of measuring range	storage temperature	-10 ... 50 °C
integration via	con::cube con::lyte con::nect	conformity - EMC	EN 61326-1, EN 61326-2-3
power supply	11 ... 15 VDC	conformity - safety	EN 61010-1
power consumption (typical)	4.2 W	standard warranty	2 years
power consumption (max.)	20 W	extended warranty (optional)	3 years
interface to s::can terminals	MIL connector, RS485		
interface to third party terminals	con::nect incl. gateway modbusRTU		
cable length	7.5 m fixed cable (-075) or 1 m fixed cable (-010)		
cable type	PU jacket		
housing material	stainless steel 1.4404		

municipal WWTP aeration

		parameter					part number
		TSS est [mg/l]	COD f [mg/l]	NO ₂ -N [mg/l]	NO ₃ -N [mg/l]	UV254 [Abs/m]	
spectro::lyser™ UV (TSS est, NO ₃ -N, CODf, UV254, NO ₂ -N)	min.	0	0	0	0	0	SP-2-001-p0-s-NO-010 / -075 (incl. Global Calibration I2)
	max.	6000	1200	500	100	2500	

spectro::lyser™ industrial

spectro::lyser™ industrial monitors depending on the application an individual selection of: TSS, turbidity, NO₃-N, COD, BOD, TOC, DOC, UV254, NO₂-N, color, BTX, O₃, HS-, AOC, fingerprints, spectral alarms and temperature

- s::can plug & measure
- measuring principle: UV-Vis spectrometry over the total range (190-750 nm)
- ideal for industrial waste water and sewer applications
- factory precalibrated, with advanced calibration service included
- long term stable and maintenance free in operation
- automatic cleaning with compressed air
- mounting and measurement directly in the media (InSitu) or in a flow cell (monitoring station)
- adaption of optical path lengths to 35 mm, 15 mm, 5 mm, 2 mm, 1 mm or 0.5 mm possible
- easy mounting without clogging
- Suitable for use in hazardous areas where explosive atmospheres are present: zone 1 & 2



up to 10 bar
operating pressure



explosion proof
specification



advanced calibration
service

recommended accessories

part number	article name
B-32-xxx	s::can compressor
D-315-xxx	con::cube
F-120-V3	carrier s::can spectrometer V3 & V2 probe, vertical attachment
F-48-V3	spectrometer V3 & V2 flow-cell (bypass setup), PVC
S-11-xx-moni	moni::tool Software

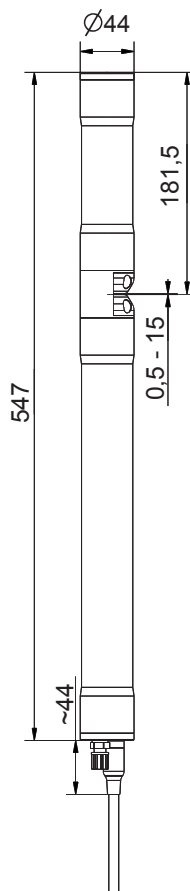

technical specification

measuring principle	UV-Vis spectrometry 190 - 750 nm UV spectrometry 190 - 390 nm	cable type	PU jacket
measuring principle detail	xenon flash lamp, 256 photo diodes	housing material	stainless steel 1.4404
automatic compensation instrument	two beam measurement, complete spectrum	window material	optical path length 5 ... 0.5 mm: sapphire optical path length 35 mm: fused silica (UV-grade)
automatic compensation cross sensitivities	turbidity / solids / organic substances	weight (min.)	3.4 kg (incl. cable)
precalibrated ex-works	all parameters	dimensions (Ø x l)	44 mm x 547 mm / 591 mm
accuracy standard solution (>1 mg/l)	NO ₃ -N: +/- 2% +1/OPL[mg/l]* COD-KHP: +/-2% +10/OPL[mg/l]* (* OPL ... optical pathlength in mm)	operating temperature	0 ... 45 °C
access to raw signals	access to spectral information	operating pressure	0 ... 10 bar
reference standard	distilled water	explosion proof specification (optional)	RL 2014/34/EU, TÜV-A16 ATEX 3001Q ATEX Marking: II 2 G Ex db IIC T6 Gb
onboard memory	656 KB	installation / mounting	submersed or in a flow cell
integrated temperature sensor	-10 ... 50 °C	flow velocity	3 m/s (max.)
resolution temperature sensor	0.1 °C	mechanical stability	30 Nm
integration via	con::cube con::lyte con::nect	ingress protection class	IP68
power supply	11 ... 15 VDC	automatic cleaning	media: compressed air or autobrush
power consumption (typical)	4.2 W	storage temperature	-10 ... 50 °C
power consumption (max.)	20 W	conformity - EMC	EN 61326-1, EN 61326-2-3
interface to s::can terminals	MIL connector, RS485	conformity - safety	EN 61010-1
interface to third party terminals	con::nect incl. gateway modbusRTU	standard warranty	2 years
cable length	7.5 m fixed cable (-075) or 1 m fixed cable (-010)	extended warranty (optional)	3 years

paper mill WWTP influent

		parameter					part number
		TSS [mg/l]	COD [mg/l]	COD f [mg/l]	UV254 [Abs/m]	UV254 f [Abs/m]	
spectro::lyser™ UV-Vis (TSS, COD, CODf, UV254, UV254f)	min.	0	0	0	0	0	SP-1-002-p0-s-EX-010 / -075 (incl. Global Calibration p1)
	max.	3000	5000	4250	1250	1000	

paper mill WWTP effluent

		parameter						part number
		TSS [mg/l]	COD [mg/l]	COD f [mg/l]	NO ₃ -N [mg/l]	UV254 [Abs/m]	UV254 f [Abs/m]	
spectro::lyser™ UV-Vis (TSS, NO ₃ -N, COD, CODf, UV254, UV254f)	min.	0	0	0	0	0	0	SP-1-002-p0-s-EX-010 / -075 (incl. Global Calibration q1)
	max.	1000	350	350	10	1250	1000	

brewery WWTP influent

		parameter				part number
		TSS [mg/l]	COD [mg/l]	UV254 [Abs/m]	UV254 f [Abs/m]	
spectro::lyser™ UV-Vis (TSS, COD, UV254, UV254f)	min.	0	0	0	0	SP-1-002-p0-s-EX-010 / -075 (incl. Global Calibration b1)
	max.	5000	45000	1250	1000	

municipal sewer

		parameter							part number	
		TSS [mg/l]	BOD [mg/l]	COD [mg/l]	COD f [mg/l]	NO ₃ -N [mg/l]	HS- [mg/l]	UV254 [Abs/m]	UV254 f [Abs/m]	
spectro::lyser™ UV-Vis (TSS, NO ₃ -N, COD, BOD, UV254, UV254f)	min.	0	0	0		0		0	0	SP-1-002-p0-s-EX-010 / -075 (incl. Global Calibration i3)
	max.	3000	2000	3750		40		1250	1000	
spectro::lyser™ UV-Vis (TSS, NO ₃ -N, COD, CODf, UV254, UV254f)	min.	0		0	0	0		0	0	SP-1-002-p0-s-EX-010 / -075 (incl. Global Calibration i1)
	max.	3000		3750	1250	40		1250	1000	
spectro::lyser™ UV-Vis (TSS, NO ₃ -N, COD, HS-, UV254, UV254f)	min.	0		0		0	0	0	0	SP-1-002-p0-s-EX-010 / -075 (incl. Global Calibration i5)
	max.	3000		3750		40	25	1250	1000	

spectro::lyser™ titanium pro

spectro::lyser™ titanium pro monitors depending on the application an individual selection of: TSS, turbidity, NO₃-N, COD, BOD, TOC, DOC, UV254, NO₂-N, color, BTX, O₃, HS-, AOC, fingerprints, spectral alarms and temperature

- s::can plug & measure
- measuring principle: UV-Vis spectrometry over the total range (190-750 nm)
- ideal for industrial waste water, desalination and sea water
- rugged design with titanium grade 2 housing
- factory precalibrated, with advanced calibration service included
- long term stable and maintenance free in operation
- automatic cleaning with compressed air or brush
- mounting and measurement directly in the media (InSitu) or in a flow cell (monitoring station)
- multiparameter probe with adjustable open path length
- adaption of optical path lengths to 35 mm, 5 mm, 2 mm or 0.5 mm possible
- easy mounting without clogging



up to 10 bar operating pressure



up to 50 °C operating temperature



highly resistant titanium grade 2

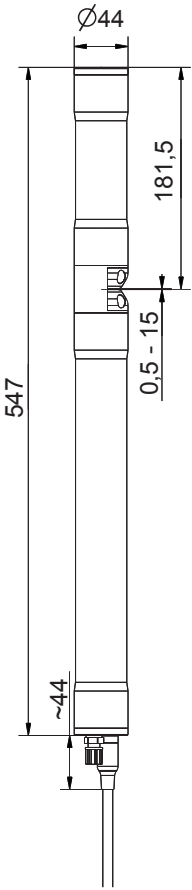

recommended accessories	
part number	article name
B-32-xxx	s::can compressor
B-44	cleaning valve
B-44-2	
D-315-xxx	con::cube
F-120-V3	carrier s::can spectrometer V3 & V2 probe, vertical attachment
F-48-V3	spectrometer V3 & V2 flow-cell (bypass setup), PVC
S-11-xx-moni	moni::tool Software

technical specification			
measuring principle	UV-Vis spectrometry 190 - 750 nm UV spectrometry 190 - 390 nm	interface to third party terminals	con::nect incl. gateway modbusRTU
measuring principle detail	xenon flash lamp, 256 photo diodes	cable length	7.5 m fixed cable (-075) or 1 m fixed cable (-010)
automatic compensation instrument	two beam measurement, complete spectrum	cable type	PU jacket
automatic compensation cross sensitivities	turbidity / solids / organic substances	housing material	titanium grade 2 (3.7035)
precalibrated ex-works	all parameters	window material	optical path length 5 ... 0.5 mm: sapphire optical path length 35 mm: fused silica (UV-grade)
accuracy standard solution (>1 mg/l)	NO ₃ -N: +/- 2% +1/OPL[mg/l]* COD-KHP: +/-2% +10/OPL[mg/l]* (* OPL ... optical pathlength in mm)	weight (min.)	2.8 kg (incl. cable)
access to raw signals	access to spectral information	dimensions (Ø x l)	44 mm x 547 mm / 591 mm
reference standard	distilled water	operating temperature	0 ... 50 °C
onboard memory	656 KB	operating pressure	0 ... 10 bar
integrated temperature sensor	-10 ... 50 °C	installation / mounting	submersed or in a flow cell
resolution temperature sensor	0.1 °C	flow velocity	3 m/s (max.)
integration via	con::cube con::lyte con::nect	mechanical stability	30 Nm
power supply	11 ... 15 VDC	ingress protection class	IP68
power consumption (typical)	4.2 W	automatic cleaning	media: compressed air or autobrush
power consumption (max.)	20 W	storage temperature	-10 ... 50 °C
interface to s::can terminals	MIL connector, RS485	conformity - EMC	EN 61326-1, EN 61326-2-3
		conformity - safety	EN 61010-1
		standard warranty	2 years
		extended warranty (optional)	3 years

paper mill WWTP effluent								
		parameter						
		TSS [mg/l]	COD [mg/l]	COD f [mg/l]	NO ₃ -N [mg/l]	UV254 [Abs/m]	UV254 f [Abs/m]	part number
spectro::lyser™ UV-Vis (TSS, NO ₃ -N, COD, CODf, UV254, UV254f)	min.	0	0	0	0	0	0	SP-1-002-p0-s-TI-010 / -075 (incl. Global Calibration q1)
	max.	1000	350	350	10	1250	1000	

brewery WWTP influent						
		parameter				
		TSS [mg/l]	COD [mg/l]	UV254 [Abs/m]	UV254 f [Abs/m]	part number
spectro::lyser™ UV-Vis (TSS, COD, UV254, UV254f)	min.	0	0	0	0	SP-1-002-p0-s-TI-010 / -075 (incl. Global Calibration b1)
	max.	5000	45000	1250	1000	

dairy WWTP influent								
		parameter						
		TSS [mg/l]	COD [mg/l]	COD f [mg/l]	NO ₃ -N [mg/l]	UV254 [Abs/m]	UV254 f [Abs/m]	part number
spectro::lyser™ UV-Vis (TSS, NO ₃ -N, COD, CODf, UV254, UV254f)	min.	0	0	0	0	0	0	SP-1-500-p0-s-TI-010 / -075 (incl. Global Calibration m1)
	max.	6000	12500	6000	80	2500	2000	

i::scan



i::scan

i::scan monitors depending on the application an individual selection of: TSS, COD, COD f, UV254, UV254 f, color, UVT10, UVT10 f and temperature

- s::can plug & measure
- new light emitting technology
- no consumables, no moving parts
- special, non-fouling optical window material
- low power consumption (less than 1 W typical)
- dual-beam compensated optics
- optional automatic cleaning compressed air (InSitu, only for version -075 with fixed cable) or autobrush
- long term stable, 100 % corrosion free
- plug connection or fixed cable
- 5000 hours maintenance free operation
- mounting and measurement directly in the media (InSitu) or in a flow cell (monitoring station)
- can be mounted directly in a mains pipe / pressure pipe
- operation via s::can terminals & s::can software

recommended accessories

part number	article name
B-32-xxx	s::can compressor
D-315-xxx	con::cube
D-320-xxx	con::lyte
F-110-iscan	carrier i::scan, for easy horizontal attachment
F-120-iscan	carrier i::scan, for easy vertical attachment
F-48-iscan	flow cell for i::scan (waste water), PVC
F-48-process	process connection 1", PVC
S-11-xx-moni	moni::tool Software

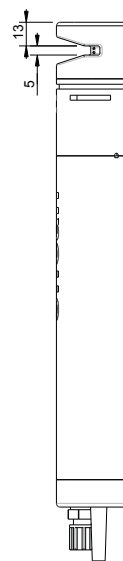
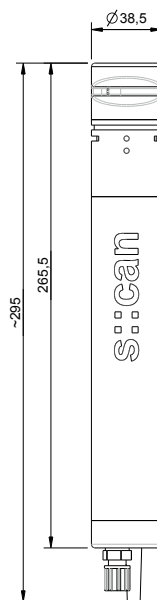

technical specification

measuring principle	spectrometry	power consumption (max.)	200 mA @ 12V
resolution	COD: 0.035 mg/l color: 0.07 Hazen UV254: 0.105 Abs/m	interface to s::can terminals	RS485, MODBUS
accuracy (standard solution)	COD: 5 mg/l or +/- 2.5 %* color: 7 Hazen or +/- 2.5 %* UV254: 1 Abs/m or +/- 2.5 %* (*whichever is greater)	cable length	7.5 m fixed cable (-075)
precalibrated ex-works	all parameters	housing material	PEEK, POM-C
reference standard	distilled water	weight (min.)	approx. 330 g
onboard memory	512 MB	dimensions (Ø x l)	38.5 x 295 mm
integrated temperature sensor	-20 ... 70 °C	operating temperature	0 ... 45 °C
resolution temperature sensor	0.06 °C	operating pressure	0 ... 8 bar
integration via	con::cube con::lyte con::nect	installation / mounting	submersed
power supply	10 ... 18 VDC	flow velocity	3 m/s (max.)
power consumption (typical)	20 mA @ 12V	automatic cleaning	with autobrush or compressed air (only possible for version (-075) with fixed cable) permissible pressure: 3 ... 6 bar
		storage temperature	-20 ... 60 °C
		conformity - EMC	EN 61326-1 EN 61326-2-3
		protection class (-075)	IP68

WWTP effluent

		parameter								
		TSS [mg/l]	color (app) [Hazen]	color (tru) [Hazen]	COD [mg/l]	COD f [mg/l]	UV254 [Abs/m]	UV254 f [Abs/m]	UVT10 [%]	part number
i::scan_TSS+COD_eq+Color+UV254	min.	0	0	0	0	0	0	0		Y12-3-e-075
	max.	500	3500	3500	500	300	500	500		
i::scan_TSS+COD_eq+UV254	min.	0			0	0	0	0		Y11-3-e-075
	max.	500			500	300	500	500		
i::scan_TSS+Color	min.	0	0	0						Y08-1-e-075
	max.	500	3500	3500						
i::scan_TSS+UV254	min.	0					0	0	0	Y09-2-e-075
	max.	500					500	500	100	
i::scan_TSS+UV254+Color	min.	0	0	0			0	0	0	Y10-2-e-075
	max.	500	3500	3500			500	500	100	

WWTP influent

		parameter								
		TSS [mg/l]	color (app) [Hazen]	color (tru) [Hazen]	COD [mg/l]	COD f [mg/l]	UV254 [Abs/m]	UV254 f [Abs/m]	part number	
i::scan_TSS+COD_eq+Color+UV254	min.	0	0	0	0	0	0	0	Y12-3-i-075	
	max.	1000	3500	3500	1500	500	500	500		
i::scan_TSS+COD_eq+UV254	min.	0			0	0	0	0	Y11-3-i-075	
	max.	1000			1500	500	500	500		
i::scan_TSS+Color	min.	0	0	0					Y08-1-i-075	
	max.	1000	3500	3500						
i::scan_TSS+UV254	min.	0					0	0	Y09-2-i-075	
	max.	1000					500	500		
i::scan_TSS+UV254+Color	min.	0	0	0			0	0	Y10-2-i-075	
	max.	1000	3500	3500			500	500		



Ionselective Probes



ammo::lyser in waste water effluent



ammo::lyser mounted on railing

ISE-Probes



fig.1: ammo::lyser™ - electrodes

“Why do we measure”

Already in the sewer system substances containing organic nitrogen, introduced by normal households as well as industry, are partly converted into ammonium. When applied in the influent of waste water treatment plants, the ion selective multi-parameter probe ammo::lyser™ continuously monitors the ammonium concentration entering the plant. Using this input, the waste water treatment plant is able to adjust its process operations according to the changing contaminant loads. As strongly acidic or alkaline conditions reduce the efficiency of the microbial processes in the waste water treatment the simultaneously performed pH measurement is valuable as well.

When used at strategic points in the sewer system, the ammo::lyser™ can assist in localisation of ammonium sources. As such it can be used for the calculation of freight based treatment costs as well as for continuous monitoring of industrial dischargers. As soon as the true concentration of ammonium to be removed from the waste water is known, it is possible to optimise the design of reservoirs and treatment plants accordingly (most often the planned infrastructure can be reduced in size).

During the biological nitrogen removal ammonium is converted into nitrite and nitrate by activated sludge. This nitrification can be controlled online using the ammonium concentration directly as process control input to maximise ammonium conversion and to minimise the amount of oxygen used for aeration at the same time. The pH value simultaneously provided by the ammo::lyser™ is important as well as the microorganisms of the activated sludge perform best at pH close to 7. As an addition to the obligatory oxygen measurement the ammo::lyser™ makes the nitrification process transparent and helps prevent possible plant breakdowns by recognising them in their earliest stage.

In addition, the ammo::lyser can be equipped with a ISE-nitrate electrode in order to be able to monitor the most common nitrogen parameters NO₃-N and NH₄-N simultaneously. Waste water treatment plants and also environmental agencies have already been using ammo::lysers for years now.

The ammo::lyser™ can even be used in the final effluent of nitrifying waste water treatment plants to monitor low concentrations of ammonium discharged into the recipient waters reliably.

ISE-Probes

“How do we measure”

All s::can ISE probes are ion selective multiparameter probes that can measure multiple water quality parameters continuously (On-Line) and directly in the water without the need for complex and maintenance intensive sample pre-treatment.

As all s::can ISE probes can be operated according to the “plug and measure” principle. With a simple plug connection, which provides power supply and data communication. The s::can sensors are connected to an s::can terminal and are ready for use. All s::can ISE probes are pre-calibrated ex works. The “plug & measure” principle avoids complex installation procedures on site and thus does not only save time during initial operation, but also reduces avoidable errors to a minimum.

The highly optimised design completely eliminates all moving parts in contact with the water. This reduces failures, spare part costs and maintenance dramatically.

Using standardised mounting devices, s::can ISE probes can be installed quickly and effortlessly, either submersed (InSitu) or in a flow through setup (Bypass, monitoring station).

s::can ISE probes utilise an automatic cleaning system that uses compressed air for removal of fouling. This system has proven highly efficient and reliable, even in untreated wastewater. Because of this, regular manual cleaning is not required, thus significantly reducing maintenance for the operator.

Like all other s::can instruments, s::can ISE probes are intelligent instruments and recognise and communicate all measurement related and technical issues as soon as they occur.

Although typically not or not often required, it is possible to adjust the calibration of the ammo::lyser™ to the actual matrix in which it is operated, in case deviations between online readings and reference analyses should be observed. Even the validation of the accuracy of the local calibration can be performed without taking the instrument out of the water.

The robust ion selective membrane has a typical lifetime of 6 months in applications with low NH₄-N concentrations, e.g. in river water. In applications with higher ammonium loads, as in waste water influent, the typical lifetime of the membrane increases to as much as 1 to 2 years.

In order to compensate possible interferences online and automatically the ammo::lyser™ can measure potassium, pH and temperature all together with ammonium. In some applications substantial changes in these parameters can be observed, which interfere with the ammonium measurement. Thus online measurements are used to eliminate this influence and allow an ammonium measurement with the highest possible accuracy. The results of these additional sensors (see figure 1: ammo::lyser™ electrodes) can be displayed as well. When applying the ammo::lyser™ in waters of stable compositions or high concentrations of ammonium, the need to perform such compensations is much reduced. Under such circumstances the unique selectivity of the ammonium membrane is sufficient to achieve reliable measurement results.

Using the combination of innovative algorithms that model the Nernst equation and extensive compensation of possible interferences makes it possible to apply the ammo::lyser™ also in low concentration ranges (below 0.5 mg/L), throughout applications where ion selective sensors of other manufacturers do not function satisfactory.

The durable membranes of the ammo::lyser™ can be exchanged individually when necessary - without the need to replace expensive electrodes or even complete cartridges. The unique non-porous, solid-state reference electrode ensures long lifetime - in this way the regular costs for spare parts are reduced to a minimum.

Its unrivalled measurement features in combination with the lowest possible total costs - initial cost and foreseeable operational costs - make the s::can ISE probe the most attractive solution available today.

ammo::lyser™ pro

ammo::lyser™ III pro monitors NH₄-N and temperature
 ammo::lyser™ IV pro+pH monitors NH₄-N, temperature and pH
 ammo::lyser™ IV pro+NO₃-N monitors NH₄-N, temperature and NO₃-N

- s::can plug & measure
- measuring principle: ISE (ionselective electrodes) - with potassium compensation
- multiparameter probe
- long term stable, factory precalibrated
- automatic cleaning with compressed air
- easy & quick mounting and measurement directly in the media (InSitu) or in a flow cell (monitoring station)
- ISE refurbishment - the easy way to minimise maintenance
- unique, non-porous / non-leaking reference electrode for technically unrivalled and consistent performance
- operation via s::can terminals & s::can software
- automatic temperature and potassium compensation, pH compensation possible
- ideal for surface water, ground water, drinking water and waste water
- minimal maintenance
- life time of ISE: typically 6 month (for applications <1mg/l NH₄-N), resp. 1 to 2 years (for applications >1mg/l NH₄-N)
- plug connection or fixed cable

recommended accessories

part number	article name
F-11-oxi-ammo	carrier oxi::lyser / soli::lyser / s::can ISE probes
F-45-process	process connection 1/4" G
C-210-sensor	10 m extension cable for s::can physical probes and s::can ISE probes
B-44	cleaning valve
B-44-2	
F-48-ammo	ammo::lyser flow-cell (by-pass setup), PVC



technical specification	
measuring principle	ISE
measuring principle detail	NH4-N: ionophore membrane K: ionophore membrane pH: non-porous reference electrode NO3-N: ionophore membrane
resolution	NH4-N, K, NO3-N, Cl, F: 0.01 at 0.02 ... 19.99 mg/l 0.1 at 20.0 ... 99.9 mg/l 1 at 100 ... 1000 mg/l T: 0.1 °C
accuracy (standard solution)	NH4-N: +/-3% or +/-0.1mg/l* (*whichever is greater)
automatic compensation cross sensitivities	E-532-pro-xxx: temp, K E-532-pro-pH-xxx: temp, pH, K E-532-pro-NO3-N-xxx: temp, K
precalibrated ex-works	all parameters
response time (T90)	60 ... 0 sec.
integration via	con::cube con::nect con::lyte
power supply	10 ... 30 VDC
power consumption (typical)	0.72 W
interface to s::can terminals	sys plug (IP67), RS485
cable length	7.5 m fixed cable (-075) or plug connection (-000)
cable type	PU jacket
housing material	stainless steel 1.4571, POM-C
weight (min.)	2.7 kg
dimensions (Ø x l)	60 x 326 mm
operating temperature	0 ... 60 °C
operating pressure	0 ... 1 bar
installation / mounting	submersed or in a flow cell
process connection	bayonet
flow velocity	0.01 m/s (min.) 3 m/s (max.)
automatic cleaning	media: compressed air permissible pressure: 2 ... 4 bar
storage temperature (electrode)	2 ... 40 °C
storage temperature (sensor)	2 ... 40 °C
conformity - EMC	EN 50081-1 EN 50082-1 EN 60555-2 EN 60555-3
conformity - safety	EN 61010-1
protection class (-000)	IP67
protection class (-075)	IP68

measuring range							
		parameter					part number
		NH ₄ -N [mg/l]	NO ₃ -N [mg/l]	K [mg/l]	pH [pH]	temperature [°C]	
ammo::lyser™ III pro (NH ₄ -N, K, temp)	min.	0.1		1		0	E-532-pro-000 / -075
	max.	1000		1000		60	
ammo::lyser™ IV pro+NO ₃ -N (NH ₄ -N, NO ₃ -N, K, temp)	min.	0.1	0.3	1		0	E-532-pro+NO ₃ -N-000 / -075
	max.	1000	1000	1000		60	
ammo::lyser™ IV pro+pH (NH ₄ -N, pH, K, temp)	min.	0.1		1	2	0	E-532-pro+pH-000 / -075
	max.	1000		1000	12	60	

ammo::lyser™ eco

- ammo::lyser™ II eco: monitors NH₄-N and temperature
- ammo::lyser™ III eco+pH additionally monitors pH
- ammo::lyser™ III eco+NO₃-N additionally monitors NO₃-N
- ammo::lyser™ III eco+Cl⁻ additionally monitors chloride
- ammo::lyser™ IV eco+pH+NO₃-N additionally monitors pH and NO₃-N
- ammo::lyser™ VI eco+pH+Cl⁻ additionally monitors pH and chloride

- s::can plug & measure
- measuring principle: ISE (ionselective electrodes) - without potassium compensation
- multiparameter probe
- long term stable, factory precalibrated
- minimal maintenance, automatic cleaning with compressed air
- unique, non-porous / non-leaking reference electrode for technically unrivalled and consistent performance
- ISE refurbishment - the easy way to minimise maintenance
- easy & quick mounting and measurement directly in the media (InSitu) or in a flow cell (monitoring station)
- automatic temperature compensation and pH compensation possible
- ideal for surface water, ground water, drinking water and waste water
- life time of ISE: typically 6 month (for applications <1mg/l NH₄-N), resp. 1 to 2 years (for applications >1mg/l NH₄-N)
- plug connection or fixed cable

recommended accessories

part number	article name
B-44	cleaning valve
B-44-2	
C-210-sensor	10 m extension cable for s::can physical probes and s::can ISE probes
F-11-oxi-ammo	carrier oxi::lyser / soli::lyser / s::can ISE probes
F-48-ammo	ammo::lyser flow-cell (by-pass setup), PVC

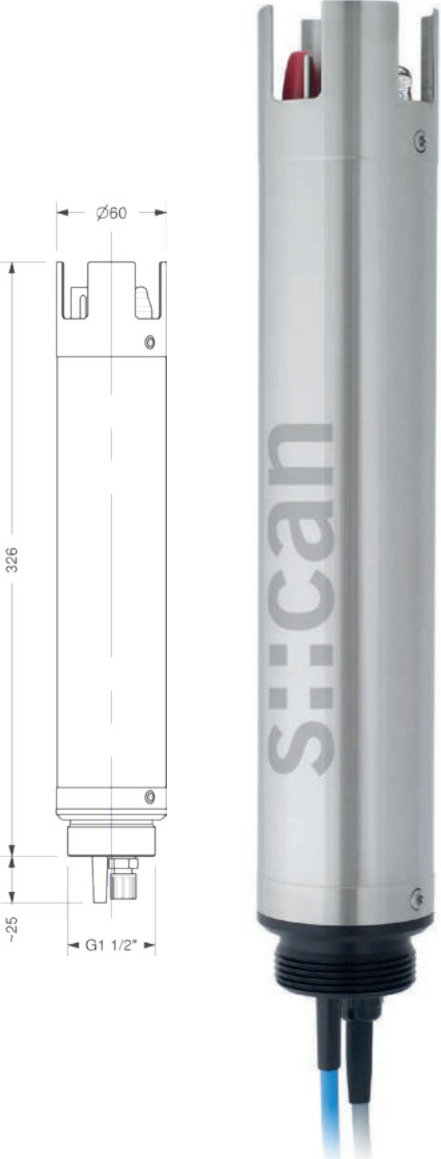

technical specification	
measuring principle	ISE
measuring principle detail	NH4-N: ionophore membrane pH: non-porous reference electrode NO3-N: ionophore membrane Cl-: ionophore membrane
resolution	NH4-N, K, NO3-N, Cl, F: 0.01 at 0.02 ... 19.99 mg/l 0.1 at 20.0 ... 99.9 mg/l 1 at 100 ... 1000 mg/l T: 0.1 °C
accuracy (standard solution)	NH4-N: +/-3% or +/-0.5mg/l* (*whichever is greater)
automatic compensation cross sensitivities	E-532-eco-xxx: temp E-532-eco-pH-xxx: temp, pH E-532-eco-NO3-N-xxx: temp E-532-eco-NO3-N-pH-xxx: temp, pH E-532-eco-CL-xxx: temp E-532-eco-CL-pH-xxx: temp, pH
precalibrated ex-works	all parameters
response time (T90)	0 ... 60 sec.
integration via	con::cube con::lyte con::nect
power supply	10 ... 30 VDC
power consumption (typical)	0.72 W
interface to s::can terminals	sys plug (IP67), RS485
cable length	7.5 m fixed cable (-075) or plug connection (-000)
cable type	PU jacket
housing material	stainless steel 1.4571, POM-C
weight (min.)	2.7 kg
dimensions (Ø x l)	60 x 326 mm
operating temperature	0 ... 60 °C
operating pressure	0 ... 1 bar
installation / mounting	submersed or in a flow cell
process connection	bayonet
flow velocity	0.01 m/s (min.), 3 m/s (max.)
automatic cleaning	media: compressed air permissible pressure: 2 ... 4 bar
storage temperature (electrode)	2 ... 40 °C
storage temperature (sensor)	2 ... 40 °C
conformity - EMC	EN 50081-1, EN 50082-1, EN 60555-2, EN 60555-3
conformity - safety	EN 61010-1
protection class (-000)	IP67
protection class (-075)	IP68

measuring range						
		parameter				part number
		NH ₄ -N [mg/l]	NO ₃ -N [mg/l]	pH [pH]	temperature [°C]	
ammo::lyser™ II eco (NH ₄ -N, temp)	min.	0.1			0	E-532-eco-000 / -075
	max.	1000			60	
ammo::lyser™ III eco+NO ₃ -N (NH ₄ -N, temp, NO ₃ -N)	min.	0.1	0.3		0	E-532-eco-NO ₃ -N-000 / -075
	max.	1000	1000		60	
ammo_lyser_III_eco_pH (NH ₄ -N, Temp, pH)	min.	0.1		2	0	E-532-eco-pH-000 / -075
	max.	1000		12	60	
ammo::lyser™ IV eco+NO ₃ -N+pH (NH ₄ -N, temp, NO ₃ -N, pH)	min.	0.1	0.3	2	0	E-532-eco-NO ₃ -N-pH-000 / -075
	max.	1000	1000	12	60	

Physical Probes



oxi::lyser in aeration tank



soli::lyser WWTP effluent

Physical Probes

“Why do we measure”

oxi::lyser™

The main application of the oxi::lyser is the online control of the most cost intensive waste water treatment process, namely the aeration of the biological carbon and nitrogen removal. The activated sludge increases its activity with rising oxygen concentrations, but this increase is not linear: Above approximately 2.5 mg/L a further elevation in oxygen does not increase the nitrification enough to justify the rise in costs of aeration. Furthermore, too high oxygen concentrations interfere with the process of denitrification. Therefore the oxygen concentration should be controlled online in the entire biological nitrogen removal process. Using the nitro::lyser™ and the ammo::lyser™ to monitor the nitrogen continuously in combination with the oxygen the operational procedures as well as the economics of waste water treatment can be optimized.

condu::lyser

Changing salt concentrations can be detected using the sum parameter conductivity. Applied in sewer systems or in the influent of a waste water treatment plant the condu::lyser can track the significant changes in the composition of the waste water entering the plant. In this way the condu::lyser helps to prevent process breakdowns, as it can detect possible conditions toxic to the microorganisms.

pH::lyser

The pH::lyser is used in sewer systems to ensure that water discharged is within the regulated limits and in the waste water treatment plant to detect pH levels that endanger the plant or its processes as soon as possible. Not only the corrosive properties of acids and bases, but also their harmful or even toxic influence on the activated sludge, require that pH is monitored continuously. In many industries there is a need to neutralise the waste water before it can be treated or discharged. Such neutralisation processes are usually controlled using online pH measurements.

redo::lyser

Measuring the oxidation-reduction potential continuously for control of biological nitrogen removal is being increasingly replaced by monitoring nitrate or ammonium online. However, especially the inflection points in the ORP registered by the redo::lyser are well known and often irreplaceable parameters for the process control of the biological waste water treatment.

soli::lyser

The level of solids in aeration basins is an essential parameter for the process control of waste water treatment plants. The concentration of suspended solids measured by the soli::lyser can be used for the optimisation of the biological treatment processes (i.e. nitrification, denitrification as well as phosphorus elimination) and for the control of sludge recirculation.



fig.1: oxi::lyser™



fig.2: condu::lyser



fig.3: pH::lyser

s::can
Intelligent. Optical. Online.

- Spektrometer-sonden
- i::scan
- Ionen selektive Sonden
- Physikalische Sonden
- Bediengeräte
- Software
- Systemkonfigurationen
- Messstationen
- Ersatzteile & Zubehör
- Services & Solutions

Physical Probes

“How do we measure”

Just as all other s::can instruments the s::can physical probes can be operated according to the “plug & measure” principle. With a simple plug connection, which provides power supply and data communication, the s::can probes are connected to an s::can terminal and are ready for use. All s::can probes are pre-calibrated ex works and do not require any conditioning before they can be used - all can be used continuously (OnLine) and directly in the water (InSitu). The “plug & measure” principle avoids complex installation procedures on site and thus does not only save time during initial operation, but also reduces avoidable errors.

The highly optimised design completely eliminates all moving parts in contact with the water. This reduces failures and maintenance dramatically.

Using standardised mounting devices s::can physical probes can be installed quickly and effortlessly, either submersed (InSitu) or in a flow through setup (by-pass, monitoring station).

Like all other s::can instruments s::can physical probes are intelligent instruments - amongst others local calibrations are stored on the probes and auto-diagnosis procedures are used to ensure best possible operation.

oxi::lyser™ (see fig.1)

is an optical multi-parameter probe that measures the concentration of dissolved oxygen and the temperature directly in the water. The oxi::lyser™ does not need a minimum flow to produce accurate readings and uses the temperature measurement for On-Line correction. The sensing element, which uses the principle of fluorescence for the oxygen measurement, is neither affected nor damaged by direct exposure to sunlight. Under normal conditions, fouling of the sensing element will not affect the results. However, to be sure that fouling is kept to a minimum, the oxi::lyser™ can be cleaned automatically with compressed air. The oxi::lyser uses no replaceable parts or consumables. Therefore, when operated properly there will be no costs for spare parts at all. For the oxi::lyser™ we guarantee replacement of spare parts free of charge for the first three years after delivery (upon presenting the warranty card).

condu::lyser (see fig.2)

is a probe that measures conductivity and temperature directly in the water. The condu::lyser does not require a minimum flow to produce accurate readings and uses the temperature to correct the conductivity measurement online. The 4-electrode measurement of the electrical conductivity produces results that are practically independent of possible fouling. The condu::lyser uses no replaceable parts or consumables. Therefore, when operated properly there will be no costs for spare parts at all.

pH::lyser (see fig.3)

is a multi-parameter probe that measures the pH value and temperature directly in the water. The pH::lyser uses the temperature to correct the result of the pH measurement online. The non-porous, solid-state reference electrode ensures excellent pH readings and a long lifetime of the electrode.

redo::lyser

is a probe that measures the oxidation-reduction potential (also known as redox potential) and temperature directly in the water. The non-porous, solid state reference electrode ensures excellent ORP readings and a long lifetime of the electrode.

soli::lyser

is an optical probe that measures the concentration of suspended solids directly in the water. The soli::lyser™ uses the temperature measurement for OnLine correction. Using the principle of infrared absorbance for measuring suspended solids the readings are not interfered by colours. The soli::lyser™ utilises an automatic cleaning system that uses compressed air for removal of fouling. Because of this, regular manual cleaning of the optical windows is not required, thus significantly reducing maintenance for the operator. The soli::lyser uses no replaceable parts or consumables. Therefore, when operated properly there will be no costs for spare parts at all.

Their unrivalled measurement features in combination with the lowest possible total costs - initial cost and foreseeable operational costs - make s::can sensors the most attractive solution available today

oxi::lyser™

oxi::lyser™ monitors dissolved oxygen & temperature

- s::can plug & measure
- measuring principle: optical / fluorescence
- multiparameter sensor
- ideal for surface water, ground water, drinking water and waste water
- long term stable and maintenance free in operation
- factory precalibrated
- automatic cleaning with compressed air
- mounting and measurement directly in the media (InSitu) or in a flow cell
- no flow necessary
- operation via s::can terminals & s::can software
- minimal maintenance (no consumables)



recommended accessories

part number	article name
B-44	cleaning valve
B-44-2	
C-210-sensor	10 m extension cable for s::can physical probes and s::can ISE probes
F-11-oxi-ammo	carrier oxi::lyser / soli::lyser / s::can ISE probes
F-48-oxi	oxi::lyser or soli::lyser flow-cell (by-pass setup), PVC
D-315-xxx	con::cube
D-320-xxx	con::lyte

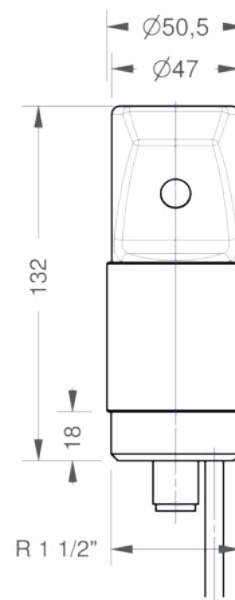

technical specification			
measuring principle	fluorescence	housing material	CPVC, stainless steel, epoxy
resolution	0.01 mg/l O ₂	weight (min.)	540 g
accuracy (standard solution)	O ₂ : +/- 0.02 mg/l or +/- 1 %* (*whichever is greater)	dimensions (Ø x l)	50.5 mm x 132 mm
response time (T90)	60 ... 0 sec.	operating temperature	0 ... 60 °C
reference standard	saturated sodium sulfite solution	operating pressure	0 ... 7 bar
integrated temperature sensor	0 ... 50 °C	installation / mounting	submersed or in a flow cell
resolution temperature sensor	0.2 °C	process connection	R 1 1/2"
integration via	con::cube con::lyte con::nect	pH range	2 ... 10
power supply	6 ... 16 VDC	ingress protection class	IP68
power consumption (max.)	0.32 W	automatic cleaning	media: compressed air permissible pressure: 2 ... 4.5 bar
interface to s::can terminals	sys plug (IP67), RS485	storage temperature	0 ... 60 °C
cable length	10 m	conformity - EMC	EN 50081-2, EN55011
		conformity - safety	EN 61000-4, EN61010-1
		extended warranty (optional)	3 years

measuring range				
		parameter		part number
		O ₂ [mg/l]	temperature [°C]	
oxi::lyser (O ₂ , temp)	min.	0	0	E-501-075
	max.	25	50	

Spectrometer Probes

i::scan

Ionselective Probes

Physical Probes

Terminals

Software

System Configuration

Monitoring Stations

Spare Parts & Accessories

Services & Solutions

pH::lyser

pH::lyser eco monitors pH & temperature

pH::lyser pro: high temperature range

- s::can plug & measure
- measuring principle: unique, non-porous / non-leaking combined reference electrode for technically unrivalled and consistent pH performance
- multiparameter sensor
- ideal for surface water, ground water, drinking water and waste water
- long term stable and maintenance free in operation
- factory precalibrated
- mounting and measurement directly in the media (InSitu) or in a flow cell
- operation via s::can terminals & s::can software
- optional: automatic cleaning with compressed air
- plug connection or fixed cable

recommended accessories

part number	article name
D-315-xxx	con::cube
D-320-xxx	con::lyte
F-12-sensor	carrier s::can physical probes
F-48-sensor	s::can Sensor flow-cell (by-pass setup), PVC
S-11-xx-moni	moni::tool Software

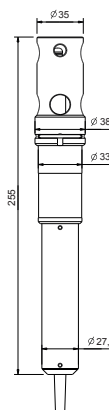
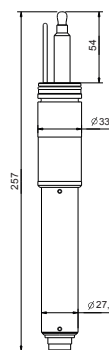

technical specification

measuring principle	potentiometric	housing material	stainless steel 1.4404/1.4401, POM-C
measuring principle detail	combined, non-porous reference electrode		or stainless steel 1.4404/1.4401, PVC (E-514-4-075)
resolution	0.01 pH	weight (min.)	400 g
accuracy (standard solution)	0.1 pH	dimensions (Ø x l)	33 x 257 mm
automatic compensation instrument	temperature	operating pressure	0 ... 10 bar
response time (T90)	30 ... 0 sec.	installation / mounting	submersed or in a flow cell
integrated temperature sensor	0 ... 90 °C	process connection	quick connect
integration via	con::cube con::lyte con::nect	flow velocity	3 m/s (max.) 0.01 m/s (min.)
power supply	9 ... 18 VDC	automatic cleaning	media: compressed air permissible pressure: 3 ... 6 bar
power consumption (typical)	0.8 W	storage temperature (electrode)	-5 ... 30 °C
power consumption (max.)	1 W	storage temperature (sensor)	-10 ... 60 °C
interface to s::can terminals	sys plug (IP67), RS485	conformity - EMC	EN 61326-1
cable length	7.5 m fixed cable (-075) or plug connection (-000)	conformity - safety	EN 61010-1
cable type	PU jacket	operating temperature (eco)	0 ... 70 °C
		operating temperature (pro)	0 ... 90 °C
		protection class (-000)	IP67
		protection class (-075)	IP68

measuring range

		parameter		part number
		pH [pH]	temperature [°C]	
pH::lyser eco (pH, temp)	min.	2	0	E-514-2-000 / -075
	max.	12	70	
pH::lyser pro (pH, temp)	min.	0	0	E-514-3-000 / -075
	max.	13	90	

redo::lyser

redo::lyser monitors ORP and temperature

redo::lyser pro: high temperature range

- s::can plug & measure
- measuring principle: unique, non-porous / non-leaking combined reference electrode for technically unrivalled and consistend ORP performance
- multiparameter sensor
- ideal for surface water, ground water and drinking water, also waste water
- long term stable and maintenance free in operation
- factory precalibrated
- mounting and measurement directly in the media (InSitu) or in flow cell
- operation via s::can terminals & s::can software
- plug connection or fixed cable

recommended accessories

part number	article name
D-315-xxx	con::cube
D-320-xxx	con::lyte
F-12-sensor	carrier s::can physical probes
F-48-sensor	s::can Sensor flow-cell (by-pass setup), PVC
S-11-xx-moni	moni::tool Software

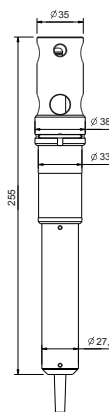
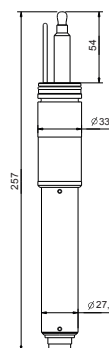

technical specification			
measuring principle	potentiometric	weight (min.)	400 g
measuring principle detail	combined, non-porous reference electrode	dimensions (Ø x l)	33 x 257 mm
resolution	1 mV	operating pressure	0 ... 10 bar
accuracy (standard solution)	+/- 10 mV	installation / mounting	submersed or in a flow cell
response time (T90)	30 ... 0 sec.	process connection	quick connect
integrated temperature sensor	0 ... 90 °C	flow velocity	0.01 m/s (min.) 3 m/s (max.)
integration via	con::cube con::lyte con::nect	automatic cleaning	media: compressed air permissible pressure: 3 ... 6 bar
power supply	9 ... 18 VDC	storage temperature (electrode)	-5 ... 30 °C
power consumption (typical)	0.8 W	storage temperature (sensor)	-10 ... 60 °C
power consumption (max.)	1 W	conformity - EMC	EN 61326-1
interface to s::can terminals	sys plug (IP67), RS485	conformity - safety	EN 61010-1
cable length	7.5 m fixed cable (-075) or plug connection (-000)	operating temperature (eco)	0 ... 70 °C
housing material	stainless steel 1.4404/1.4401, POM-C	operating temperature (pro)	0 ... 90 °C
		protection class (-000)	IP67
		protection class (-075)	IP68

measuring range		parameter		
		redox [mV]	temperature [°C]	part number
redo::lyser eco (ORP, temp)	min.	-2000	0	E-513-2-000 / -075
	max.	2000	70	
redo::lyser pro (ORP, temp)	min.	-2000	0	E-513-3-000 / -075
	max.	2000	90	

Spectrometer Probes

i::scan

Ionselective Probes

Physical Probes

Terminals

Software

System Configuration

Monitoring Stations

Spare Parts & Accessories

Services & Solutions

condu::lyser

condu::lyser monitors conductivity, temperature & salinity*

- s::can plug & measure
- measuring principle condu::lyser: 4-electrode, direct-contact measurement
- multiparameter sensor
- ideal for surface water, ground water, drinking water and waste water
- long term stable and maintenance free in operation
- factory precalibrated
- mounting and measurement directly in the media (InSitu) or in a flow cell
- operation via s::can terminals & s::can software
- plug connection or fixed cable

recommended accessories	
part number	article name
D-315-xxx	con::cube
D-320-xxx	con::lyte
F-12-sensor	carrier s::can physical probes
F-48-sensor	s::can Sensor flow-cell (by-pass setup), PVC
S-11-xx-moni	moni::tool Software

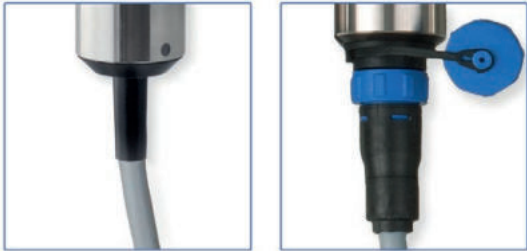

technical specification

measuring principle	4-electrode, direct-contact	weight (min.)	240 g
resolution	1 µS/cm	dimensions (Ø x l)	33 x 237 mm
accuracy (standard solution)	1% of reading	operating temperature	0 ... 70 °C
automatic compensation instrument	temperature	operating pressure	0 ... 20 bar
integrated temperature sensor	-20 ... 130 °C	installation / mounting	submersed or in a flow cell
integration via	con::cube con::lyte con::nect	process connection	quick connect
power supply	7 ... 30 VDC	flow velocity	0.01 m/s (min.) 3 m/s (max.)
power consumption (typical)	0.06 W	automatic cleaning	media: compressed air permissible pressure: 2 ... 6 bar
power consumption (max.)	0.15 W	storage temperature	0 ... 60 °C
interface to scan terminals	sys plug (IP67), RS485	conformity - EMC	EN 61326-1
cable length	7.5 m fixed cable (-075) or plug connection (-000)	protection class (-000)	IP67
housing material	Stainless steel 1.4435, FDA-approved PEEK, POM-C	protection class (-075)	IP68

measuring range

		parameter			
		conductivity [µS/cm]	temperature [°C]	salinity* [PSU]	part number
condu::lyser	min.	0	0	2	E-511-2-000 / -075
	max.	500000	70	42	

* Salinity measurement is only possible in combination with con::cube terminal



soli::lyser

soli::lyser monitors TSS or MLSS

- s::can plug & measure
- measuring principle: optical (infrared absorbance)
- ideal for waste water
- long term stable and maintenance free in operation
- factory precalibrated (2 measuring ranges available)
- automatic cleaning with compressed air
- mounting and measurement directly in the media (InSitu) or in a flow cell
- operation via s::can terminals & s::can software
- minimal maintenance (no waste parts)
- most cost efficient sensor, cost of ownership are unmatched



recommended accessories

part number	article name
F-11-oxi-ammo	carrier oxi::lyser / soli::lyser / s::can ISE probes
F-48-oxi	oxi::lyser or soli::lyser flow-cell (by-pass setup), PVC
C-210-sensor	10 m extension cable for s::can physical probes and s::can ISE probes
B-44	cleaning valve
B-44-2	
D-315-xxx	con::cube
D-320-xxx	con::lyte

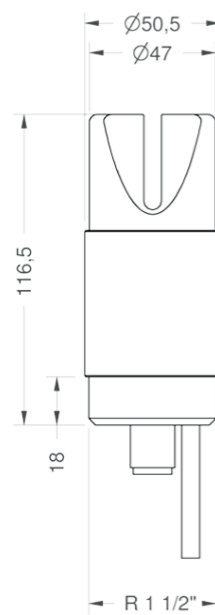

technical specification			
measuring principle	optical	power supply	6 ... 16 VDC
measuring principle detail	infrared (880nm)	power consumption (max.)	0.32 W
measuring range application	0.25 ... 30 g/l TSS/MLSS (E-505-1-075) 0 ... 1500 mg/l TSS (E-505-2-075)	interface to s::can terminals	sys plug (IP67), RS485
resolution	10 mg/l between 1000 and 9999 mg/l 100 mg/l above 10 g/l 1 mg/l below 1000mg/l	cable length	10 m
accuracy	TSS/MLSS: +/- 100 mg/l or +/- 5 %* (E-505-1-075) TSS: +/- 2 mg/l or +/- 5 %* (E-505-2-075) (*whichever is greater)	cable type	22 AWG, polyurethane jacket
repeatability	± 1 %	housing material	epoxy, stainless steel
automatic compensation instrument	temperature	weight (min.)	540 g
response time (T90)	60 ... 0 sec.	dimensions (Ø x l)	51 x 117 mm
integration via	con::cube con::lyte con::nect	operating temperature	0 ... 60 °C
		operating pressure	0 ... 6.8 bar
		installation / mounting	submersed or in a flow cell
		process connection	R 1 1/2"
		ingress protection class	IP68
		automatic cleaning	media: compressed air or autobrush permissible pressure: 2 ... 4.5 bar
		storage temperature (sensor)	0 ... 60 °C
		conformity - EMC	EN 50081-2, EN55011
		conformity - safety	EN 61000-4, EN61010-1
		extended warranty (optional)	2 years

measuring range			
		parameter	part number
soli::lyser (TSS)	min.	TSS [mg/l]	E-505-2-075
	max.	0	
soli::lyser (TSS)	min.	1500	E-505-1-075
	max.	250	
		30000	

Terminals



con::cube V3



con::lyte

con::cube V3

- s::can high-end IoT (Internet of Things) terminal based on an industrial PC, IP65
- widescreen color graphical display (9") and touch screen
- highly intuitive use, informative visualization & easy operation: time series, optical spectra and all events in clear text
- sensor and station management of up to 64 parameters: automatic cleaning, data logging, sample & calibration including history and multipoint calibration, sensor function check, user management and easy data transfer via USB-stick
- low power operation with less than 3 watts (@ 15 min. measuring interval): wide range AC and DC variants available
- IoT (Internet of Things) and M2M (Machine to Machine) connectivity: 100 Mb/s Ethernet, 300 Mb/s WLAN and optional worldwide WCDMA 4G interface, remote control (http) and data transfer into "Cloud" via FTP, SSH and TML
- process interface to SCADA via Modbus RTU/TCP, SDI-12, Profibus DP, analog 0/4-20 mA and relay outputs (state)
- integration of third-party sensors via analog 0/4-20 mA and digital (solid state) inputs, Modbus RTU/TCP
- easily extendable & all moni::tool features available: 8 slots to customize I/Os, moni::tool software pre-installed, additional software features like online data validation and event detection optional

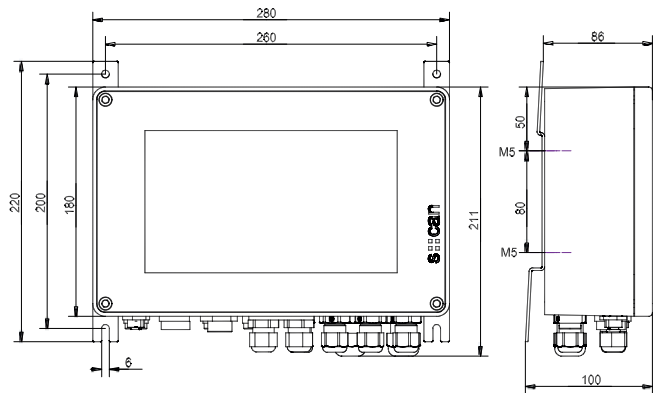

standard accessories

part number	article name
S-11-04-moni	moni::tool - Basic s::can monitoring station software for 4 parameters
D-315-out-relay	4 digital outputs (output module), provides 4 configurable relay contacts 1A
D-303-LX	Linux Application Licence (obligatory to D-330)

technical specification

integration of	1 x s::can spectrometer probe and 4 x s::can sensors or ISE probes	power supply	D-330-230: 100 ... 240 VAC D-330-024: 10 ... 36 VDC
display	color-display 9" TFT	power consumption (typical)	1.5 W (in sleep mode) 10 W (no analogue ports) 30 W (fully equipped)
function indicator	4 x LED	power consumption (max.)	20 W (no analogue ports) 60 W (fully equipped)
operation via	integrated touch-screen (optional) Ethernet - Browser or VNC WiFi - Browser or VNC USB (keyboard, mouse) 3G modem (optional)	grounding	<0.5 Ohm to process media
operating system	Linux	analog outputs	up to 8x2 x 0/4-20 mA
main memory	2 GB RAM	analog inputs	up to 8x2 x 0/4-20 mA
onboard memory	16 GB	outputs for automatic cleaning	2
interface to s::can spectrometric probes	M12 RSTS 8Y (IP67), RS485, Ethernet	digital inputs	up to 8x2 x 14 VDC
interface to s::can sensors	4 x sys plug, RS485	relay outputs	4 x 2A (500 VAC)
interface to third party sensors	Modbus RTU/TCP, analog inputs	system error relay	1 x 2A (500 VAC)
network connection	802.11n a/b/g WiFi 300Mb/s Ethernet LAN 1 Gb/s worldwide 3G HSPA+	dimensions (width x height x depth)	280 x 209 x 85 mm
interface to SCADA	Modbus RTU/TCP, Profibus DP (optional), SDI-12 (optional), analog outputs	housing material	aluminium alloy, powder coated
data transfer	via SSH, FTP, TML (XML) and USB stick	weight (min.)	4 kg
remote control	via http	operating temperature	-20 ... 50 °C
		storage temperature	-20 ... 60 °C
		storage humidity	5 ... 90 %
		ingress protection class	IP65
		conformity - EMC	EN 61326-1
		conformity - safety	IEC/EN/UL/CSA 61010-1 IEC/EN/UL/CSA 61010-2-201 IEC/EN 60529
		part number 24V	D-330-024
		part number 230V	D-330-230

recommended accessories

part number	article name
C-31-eu	Optional 2 m power cable
C-31-us	Optional 2 m power cable
D-315-3GLX	Worldwide 3D internet connection via Quad-band HSPA (up to 5.7 Mbps/21 Mbps)
D-315-in-mA	2 analogue inputs (input module), provides 2 analogue inputs (4-20mA) for integration of 3rd party readings
D-315-in-relay	2 digital inputs (input module), provides 2 digital IN (5-24V) for integration of 3rd party readings
D-315-out-mA	2 analogue outputs (output module), provides data transfer to PLC systems
D-315-out-profi-bus	provides Profibus DPV0 for data transfer to PLC systems
D-315-out-SDI12	SDI 12 (output module), provides SDI 12 for data transfer to PLC systems
D-315-anten-na-pro	External, high range antenna option for con::cube, incl. 10 m extension cable
D-315-anten-na-plug	Internal antenna adapter cable and connector, option for con::cube
S-11-autosam-pler	moni::tool - auto sampler feature
S-11-basic-PLC	moni::tool - basic PLC functionality (time control, pulsing, custom bits)
S-11-camera	moni::tool - camera input
S-11-data-export	moni::tool - automatic data transfer (via SSH, FTP, TML)
S-11-free-for-mula	moni::tool - configureable mathematic formula
S-11-SMS	moni::tool - SMS notification
S-14-vali	vali::tool - s::can data validation software
S-15-ana	ana::tool - s::can event detection software
F-51	weather shield for s::can terminals
S-20-MVA	Complete license of all moni::tool modules, vali::tool and ana::tool

con::lyte

- low-cost terminal for control applications
- power efficient LCD display and ergonomic UI
- sensor and station management of up to 2 (eco) or 6 (pro) parameters
- control of automatic cleaning, data logging, sample & calibration, sensor function check and easy data transfer via USB-stick
- process interface to SCADA or con::cube via Modbus RTU, Profibus DP, analog 4-20 mA and relay outputs (state/PWM/Pulse)
- integration of third-party sensors via analog and digital I/Os
- outstanding control features: easy threshold and alarm limits with hysteresis, 3 opt. PID or 2-point controllers
- certifications: CE, UL, CSA and RCM

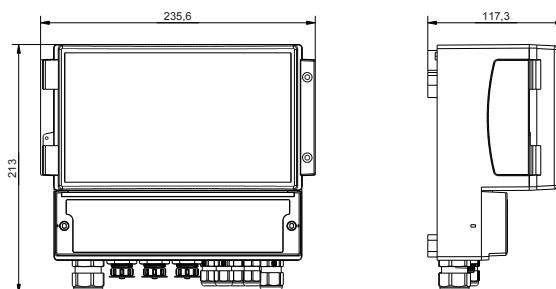

technical specification

display	LCD
function indicator	2 x LED
operation via	keypad
onboard memory	512 MB
interface to SCADA	Modbus RTU (optional), Profibus DP (optional), analog outputs
data transfer	USB stick
power supply	100-240 VAC (50-60 Hz)
power consumption (max.)	25 W
analog inputs	1 x 0/4-20 mA
outputs for automatic cleaning	1 (2nd cleaning device via relay output)
digital inputs	2
digital input flow detector	1
relay outputs	2 x 6A (600 VAC)
system error relay	1 x 6A (600 VAC)
dimensions (width x height x depth)	235.6 x 213 x 117.3 mm
housing material	PC
weight (min.)	1300 g
operating humidity	5 ... 90 %
storage temperature	-20 ... 50 °C
storage humidity	5 ... 90 %
ingress protection class	IP65
conformity - EMC	EN 61326-1
conformity - safety	EN 61010-1
conformity - RoHS 2	EN 50581

con::lyte eco (2 parameters)

integration of	1 x i::scan, s::can sensor or s::can ISE probe
interface to s::can sensors	1 x sys plug, RS485
analog outputs	2 x 4-20 mA
operating temperature (eco)	-20 ... 45 °C
part number 230V	D-320-eco-230

con::lyte pro (6 parameters)

integration of	pro1: i::scan, s::can sensors/ISE probes; pro2: s::can G::series, i::scan, s::can sensors/ISE probes
interface to s::can spectrometric probes	D320-pro2: 1 x MIL, RS485
interface to s::can sensors	D-320-pro1: 3 x sys plug, RS485 D-320-pro2: 2 x sys plug, RS485
analog outputs (optional license)	3 x 4-20 mA
analog outputs (optional module)	2 x 4-20 mA / 4 x 4-20 mA
operating temperature (pro1)	-20 ... 45 °C
operating temperature (pro2)	-20 ... 50 °C
part number 230V	D-320-pro1-230, D-320-pro2-230

recommended accessories

part number	article name
C-31-eu	Optional 2 m power cable
C-32-V3	Adapter cable to connect a V3 spectrometer (M12) to V2 Terminal (MIL Plug)
D-319-logger	Datalogger option for con::lyte
D-319-out-profibus	Profibus (output module for con::lyte)
D-320-PID	3 x PID control output for con::lyte D-320
D-320-out-mA	License for 3 analog outputs (4-20 mA) for con::lyte pro

con::nect V3

- s::can connection device for one spectrometer V3 probe and one cleaning device
- expand con::cube/con::lyte sensors networks (longer distances and higher number of sensors)
- operation of one s::can spectrometer V3 probe
- RJ45 connector for wired network access

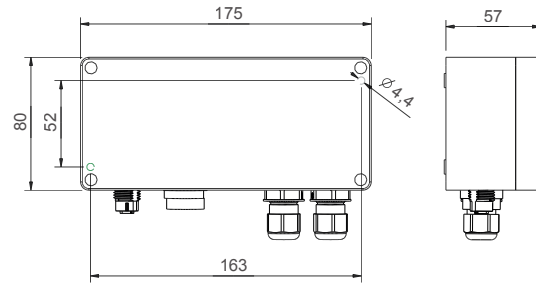

technical specification

integration of	1 x s::can spectrometer V3 probe with one cleaning device
operation via	via PC / notebook / any third party device
interface to s::can spectrometric probes	M12 RSTS 8Y (IP67), RS485, Ethernet
interface to PC	Ethernet (RJ45)
interface to SCADA	REST API / RS485
data transfer	via PC (visu::tool)
power supply	12 VDC

power consumption (max.)	passive device
outputs for automatic cleaning	1
dimensions (width x height x depth)	80 x 175 x 57 mm (w/o cable bushing)
housing material	AlSi12, powder coated
weight (min.)	600 g
operating temperature	-20 ... 50 °C
storage temperature	-20 ... 50 °C
ingress protection class	IP65
part number	B-33-012

recommended accessories

part number	article name
S-31-visu (visu::tool lyte)	visu::tool lyte/pro - Data Visualisation and Analysis Tool
S-34-visu (visu::tool pro)	
C-31-eu	Optional 2 m power cable
C-31-us	Optional 2 m power cable

Software



moni::tool™
 vali::tool ana::tool

A true software revolution that changes the face of water quality monitoring, data validation and event detection!

Why use monitoring station software?

The rising popularity of online sensors means that ever increasing amounts of data are collected. Online results increase the understanding of water quality, but the amount of data can be so enormous that it is impossible to manually verify and interpret the data. Automatic validation and event detection is therefore crucial to exploit the potential of online monitoring.

What is special about moni::tool?

s::can has developed a modular software package to improve data availability and quality. The concept looks at the whole system: hardware, software and operator. Only this all encompassing approach can guarantee that operational control and / or event detection work reliably. Using raw, unvalidated information for control or event detection will result in a high false alarm rate or in poor sensitivity.

The modular approach:

The s::can software package for water quality monitoring is split into three modules:

- **moni::tool™ - Sensor and Station Management**
 Provides management of probes and stations. It documents critical manipulations, from user login to maintenance and logbook keeping. It also has intuitive visualization tools to display all information in a clear and easy to understand format.
- **vali::tool - Data Validation**
 Automatically detects, marks and (optionally) corrects untrustworthy data. It ensures only high quality data are fed into the event detection module. It also provides the user with indications on sensor maintenance requirements, as well as automatic detection of malfunctions.
- **ana::tool - Event Detection**
 With ana::tool your existing simple water quality monitoring station morphs into a fail-safe EDS-system!

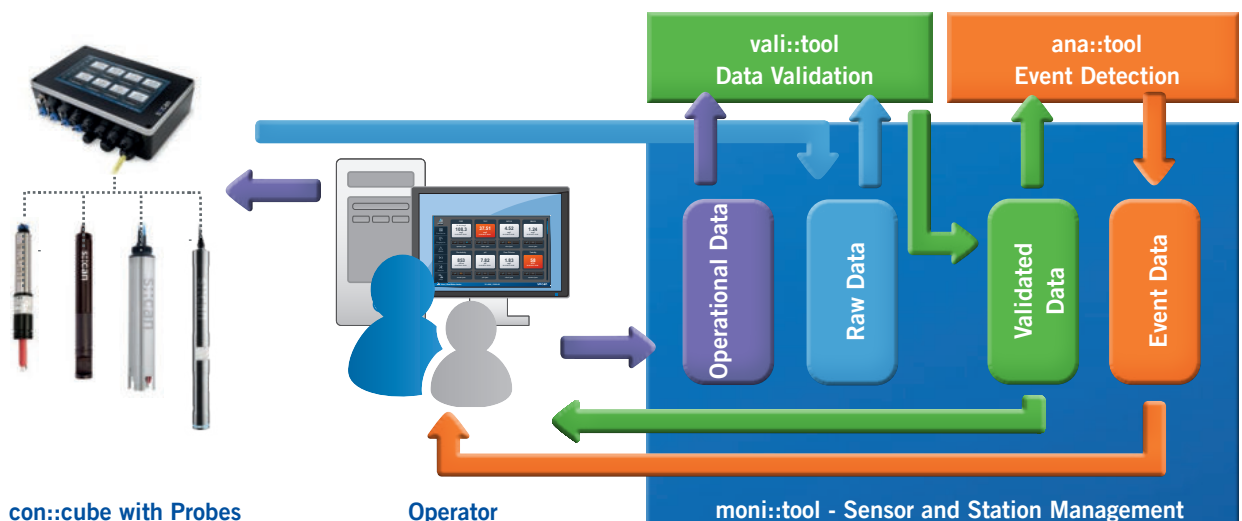

© s::can GmbH

moni::tool™

Sensor and Station Management

moni::tool™ is a revolutionary new platform for the management of an almost unlimited number of stations, online probes, analyzers and parameters. Intuitive operation - on site or remote - and reams of valuable features make moni::tool™ essential for state of the art sensor and station management.



Want to try moni::tool?
... visit monitool.s-can.at

moni::tool™ - Basic Features



- Management for an almost unlimited number of stations, sensors and parameters
- Automatic installation of all s::can sensors
- Open platform talks to any sensor type (analog 0/4-20 mA, MODBUS RTU/ TCP, solid state)



- Impressive real-time zoomable, scrollable graphical visualization of all historical data including 3D-optical spectra
- Optimal display readability with Classic-, Day- and Night-Mode



- Easy customization of tools, devices and protocols
- Clear text help messages
- Available languages: German, English, Chinese, Japanese, Spanish, France and Turkish



- Smart-phone-style, easy to use touch interface allows intuitive operation by non-expert staff
- Minimal user input necessary, Few input options = few input mistakes
- User management: Basic / Advanced / Expert user level



- Quality controlled and documented status management of probes and stations eliminates the need for paper log books
- Station and probe management for 100% transparent documentation



- Can be used in a small monitoring station as well as in the heart of a large central data collection system
- Large local database for collection and management of all incoming data
- Secure, automatic Data export



- Data Integration into any modern data exchange system
- Probes and stations can be accessed from any suitable device
- Can be run from any standard web browser e.g. via PC, Tablet, Notebook or Smart Phone



- Protected by a user-configurable firewall



- Automatic probe cleaning



- Any parameter input of any type of probe can be fed in - managed and analyzed in real time
- Multi sample function to calibrate all installed probes with minimal effort

moni::tool™ - Additional Features

Automatic File Transfer

Automatic transfer of all relevant information from con::cube to your cloud and servers

- Customizable ASCII format (csv supported)
- Import to any spreadsheet application or database (e. g. Excel)
- SSH-Transfer, FTP-Transfer and TML-Interface (XML-Based).

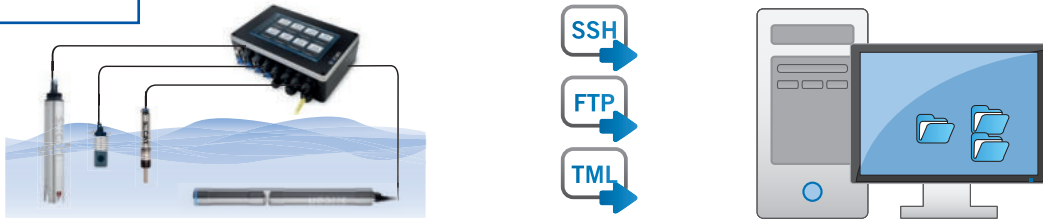

Free Formula

Offers to use virtual parameters based on online measurement results using a custom “free formula” (FF)

- Converts parameters/units, example: NO3-N can be converted to NO3
- Combines monitored parameters, example: COD and flow can be used to calculate load
- Long list of supported functions, example: multiple parameters including single wavelengths from a spectro::lyser fingerprint can be combined to create a custom Water Quality Index

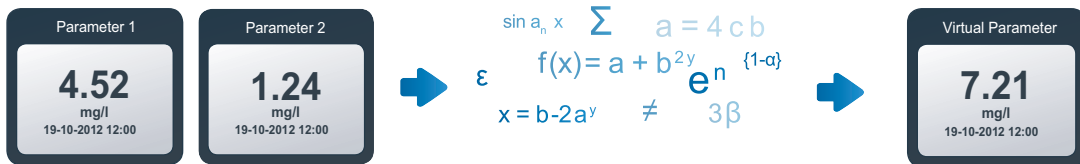

SMS Notification

Sends a SMS in case a configurable condition occurs (this function uses the optional con::cube internal modem)

- Every digital output function can be used to trigger a SMS notification
- Example conditions: parameter reading over limit, event detected, failure with installation or sensor detected, etc.
- Customizable SMS message text

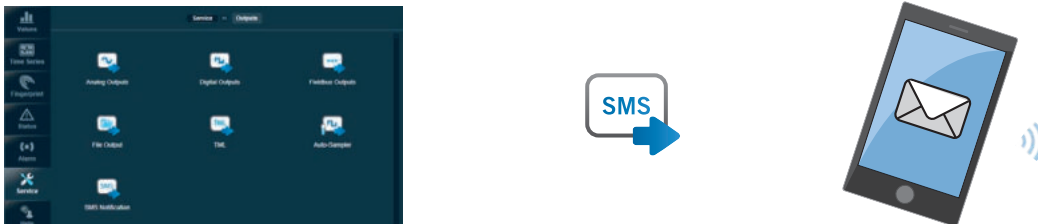

moni::tool™ - Additional Features

Auto Sampler

Create your own Auto-Sampler!

- Complete and flexible sample system
- Configure the conditions for taking samples
- Combine different conditions and program delays
- Control sample capacity either by a fill level detector or by a timer

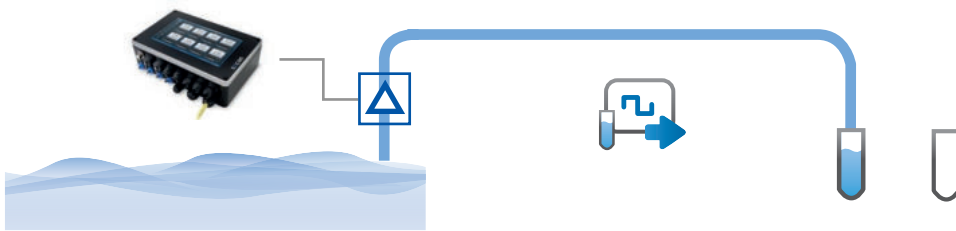

PLC Tools

Enhance the process control functionality for the con::cube digital outputs

- Time Control
- Value Hysteresis downwards
- Pulsing

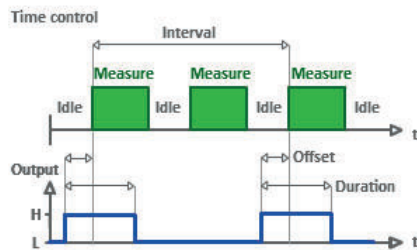

The output is time controlled by the the measurement cycle. Interval defines how often, Offset defines the relative position to the start of measurement and Duration defines how long the output is 'HIGH'.

Camera Integration

Automatically collect snapshots and watch live video stream

- Effective surveillance against vandalism
- Choose the interval of snapshots freely
- Review stored snapshots in a gallery
- Can be used with INSTAR and AXIS cameras

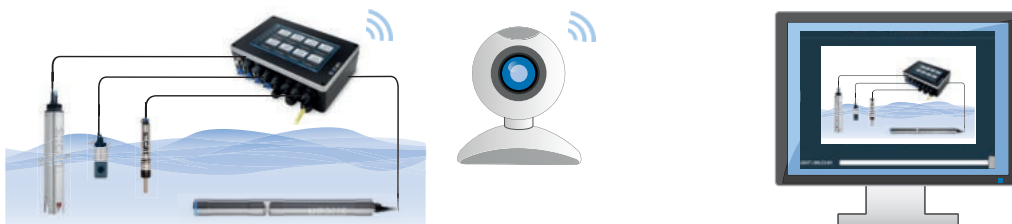

vali::tool

Data Validation

Automatic data validation makes sure that only unmarked, “clean” data are used for further analysis, training and alarms. Any non-event-related deviating data must be identified and marked before feeding them into the following event detection module.

Why is Data Validation before Event Detection important?

vali::tool automatically detects, marks and (optionally) corrects untrustworthy data, not by using mean average - it detects outliers, noise and checks for discontinuous data. It ensures only high quality data are fed into the event detection module (ana::tool). It also provides the user with indications on sensor maintenance requirements, as well as automatic detection of malfunctions.

How does vali::tool work?

The basic steps in the data validation are: outlier detection, noise detection and check for discontinuous data. The results of the data validation are presented as status information with the respective parameter and sensor. A station status symbol as well as a change in background color in the parameter display indicate that data quality is sub-optimal. Detailed notifications, including suggestions to remedy the issue or for maintenance, can be called up.

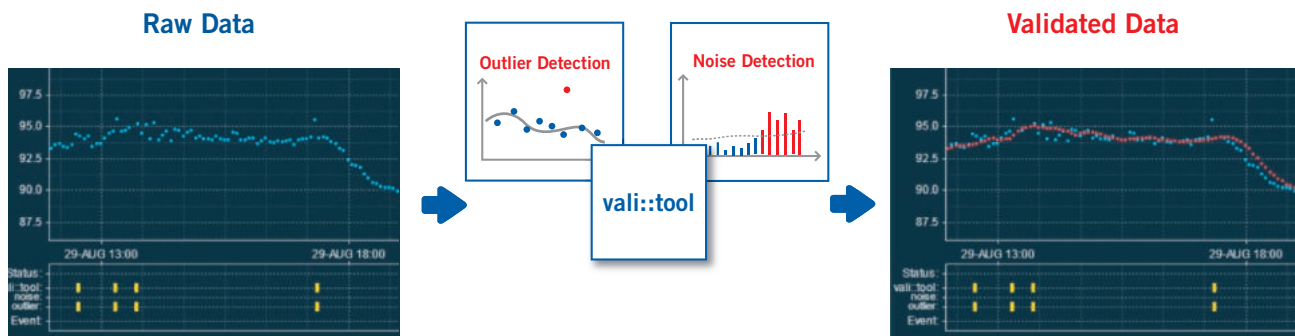

vali::tool - Highlights

- Provides self-adaptive, self-controlled data validation in real time
- Ensures both sensitive and reliable alarm limits respectively setpoints for process control
- Analyzes noise, outliers and other combinations in real time to reliably detect any malfunction at an early stage
- Considers user interventions in real-time
- Application-specific training period considers normal fluctuations of individual water matrix and typical process dynamics
- Helps to dramatically reduce false alarm rates
- Configurable auto-correction of data based on threshold, outlier and noise analysis

ana::tool

Event Detection for everyone

- Affordable for everyone
- Best available EDS
- Simple, easy to use and automatic

ana::tool turns your monitoring station into an Event Detection System!

ana::tool identifies unknown and unusual conditions and enables operators to react timely to faults in the monitored system, determines normality of these data and triggers an alarm when a significant deviation from normality is detected.

How does ana::tool work?

ana::tool evaluates measurement data that have been cleaned by the validation module. It identifies unknown and unusual conditions and enables operators to react timely to faults in the monitored system, determines normality of these data and triggers an alarm when a significant deviation from normality is detected. It combines Static Alarms, Dynamic Alarms, Pattern Recognition and Spectral Alarms.

Once an alarm is detected, the user has to provide feedback, so the system can learn what alarms are real and which ones represented normal changes in water quality. This will increase system performance over time. Gradual composition changes (e.g. seasonal variations) are accounted for by automatic training on a moving time window.

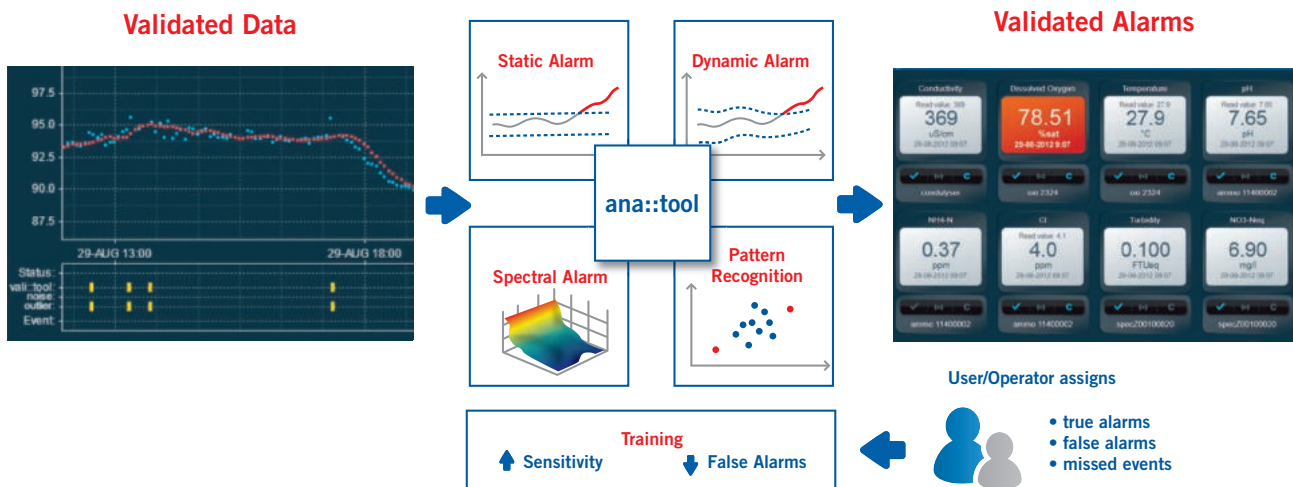

ana::tool - Highlights

- Unmatched event detection tools based on proven algorithms for real-time event detection that use data streams from all connected probes separately or in combination
- The only software developed by the market leader to be specifically capable of exploiting the enormous information contained in UV spectra which provide the most sensitive and stable data source for event detection
- ana::tool is optimized for use of multi-dimensional spectral data, but will also work with single or multiple one-dimensional inputs
- So far the only one commercial software package that was tested and found suitable by US-EPA water security division
- All event information is automatically aggregated into a “traffic light” output and a “% deviation from normal” output. Furthermore, analogue and digital outputs as well as text notifications can be triggered
- Trains itself on any type of data streams coming in, and will learn automatically which data are useful for event detection, and which ones not

moni::tool License Options

	free*	one time license fee											
	S-11-04-moni	S-11-08-moni	S-11-24-moni	S-11-64-moni	S-11-data-export	S-11-free-formula	S-11-SMS	S-11-autosampler	S-11-basic-PLC	S-11-camera	S-14-vali	S-15-ana	S-20-MVA
Basic Features	●	●	●	●									
4 Parameters	●												
8 Parameters		●											
24 Parameters			●										
64 Parameters				●									●
Automatic data transfer (via SSH, FTP, TML)					●								●
Configurable mathematical formula						●							●
SMS notification							●						●
Auto sampler feature								●					●
Basic PLC functionality (time control, pulsing, custom bits)									●				●
Camera input										●			●
vali::tool											●	●	●
ana::tool (includes vali::tool)												●	●
Affordable license for all moni::tool features, vali::tool and ana::tool													●

* The basic features for 4 parameters come free of cost with every con::cube terminal

Upgrade

S-19-subscription s::can annual upgrade package for moni::tool

Services

data::care packages

S-18-data-4 data::care - quarterly data check and basic report (annual fee, online access required)

S-18-data-12 data::care - monthly data check and basic report (annual fee, online access required)

S-18-data-52 data::care - weekly data check and basic report (annual fee, online access required)

S-VPN-hosting vpn::host - one year secure remote access from customer PC to con::cube via s::can VPN server

S-VPN-hosting-36 vpn::host - 36 months secure remote access from customer PC to con::cube via s::can VPN server

custom packages

S-12-custom-tab Custom moni::tool TAB, individual screen within moni::tool, completely adapted to customers requirements and applications, price on request after exact specification

S-12-custom-formula Custom formula, individual sophisticated mathematical formulas and algorithms, price on request after exact specification

setup+training packages

A-vf vali::tool - setup & evaluation

A-af ana::tool - training & evaluation

visu::tool lyte/pro - Data Visualisation and Analysis Tool

- visu::tool is a fast and easy-to-use data visualization software for PCs and notebooks
- in 3 simple steps you can visualize huge amounts of data from con::cube or con::lyte into single or multiple graphs
- the visu::tool “lyte” version is available for free download
- the advanced visu::tool “pro” version includes a vast amount of additional useful offline features such as data aggregation, fingerprint plots, parameter correlation
- read s::can files (.log, .par, .csv, .xlsx and .fp files)
- graphical user interface for parameter selection
- save data as Excel



technical specification

part number	S-31-visu (visu::tool lyte) S-34-visu (visu::tool pro)
-------------	---

moni::app

- moni::app is an app that allows you to have an overview of your data from the s::can terminal con::cube on your smartphone
- get the current state of your s::can monitoring station and analyze the data history
- check all parameters, time series, the water's spectral fingerprint and even the status of all your sensors
- wherever you are, simply open the app and immediately find out what is going on in real-time
- you can download moni::app for free for Android via Google Play and iOS via the Apple Store



technical specification

part number	S-50-moni-app
-------------	---------------

System Configuration

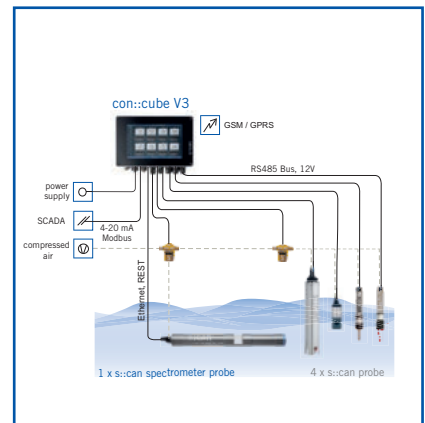

- Spectrometer Probes
- s::can
- Ionselective Probes
- Physical Probes
- Terminals
- Software
- System Configuration**
- Monitoring Stations
- Spare Parts & Accessories
- Services & Solutions

Plug & Measure - System Configuration for con::cube

- s::can high-end IoT (Internet of Things) terminal based on an industrial PC, IP65
- widescreen color graphical display (9") and touch screen
- highly intuitive use, informative visualization & easy operation: time series, optical spectra and all events in clear text
- sensor and station management of up to 64 parameters: automatic cleaning, data logging, sample & calibration including history and multipoint calibration, sensor function check, user management and easy data transfer via USB-stick
- low power operation with less than 3 watts (@ 15 min. measuring interval): wide range AC and DC variants available
- IoT (Internet of Things) and M2M (Machine to Machine) connectivity: 100 Mb/s Ethernet, 300 Mb/s WLAN and optional worldwide WCDMA 4G interface, remote control (http) and data transfer into "Cloud" via FTP, SSH and TML
- process interface to SCADA via Modbus RTU/TCP, SDI-12, Profibus DP, analog 0/4-20 mA and relay outputs (state)
- integration of third-party sensors via analog 0/4-20 mA and digital (solid state) inputs, Modbus RTU/TCP
- easily extendable & all moni::tool features available: 8 slots to customize I/Os, moni::tool software pre-installed, additional software features like online data validation and event detection optional
- process software moni::tool pre-installed; additional software tools (e.g. data validation or event detection) optional
- optional: operation in flow cell

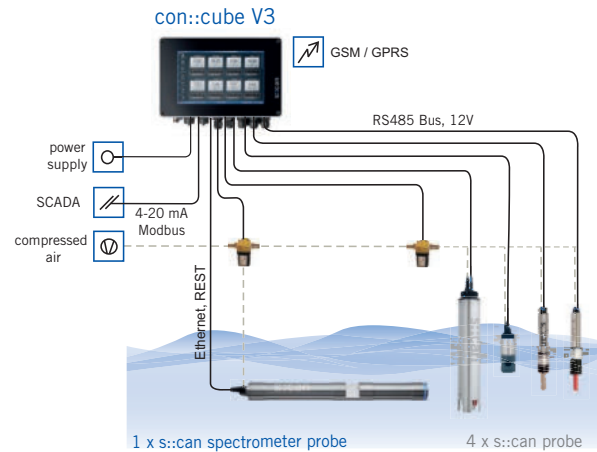

Plug & Measure - System Configuration for con::lyte pro

- s::can low-cost terminal designed for control applications
- power efficient LCD display and ergonomic user interface
- sensor and station management of up to 6 parameters
- control of automatic cleaning, data logging, sample & calibration, sensor function check and easy data transfer via USB-stick
- process interface to SCADA or con::cube via Modbus RTU, Profibus DP, analog 4-20 mA and relay outputs (state/PWM/Pulse)
- integration of third-party sensors via analog 0/4-20 mA input and digital (solid state/count) inputs
- outstanding control features: easy threshold and alarm limits with hysteresis, 3 optional PID or 2-point controllers
- certifications: CE, UL, CSA and RCM
- optional: operation in flow cell

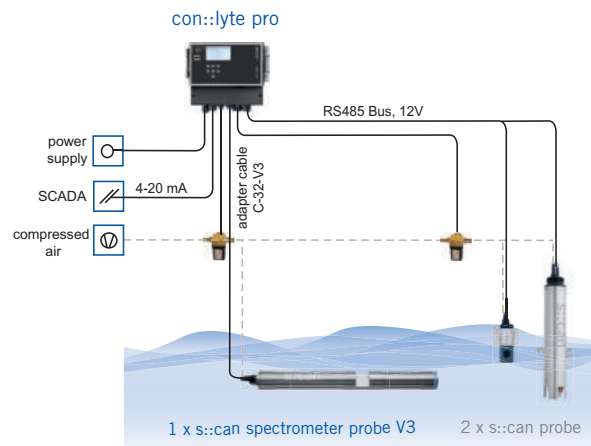

Plug & Measure - System Configuration for con::nect V3

- s::can connection device for one spectrometer V3 probe and one cleaning device
- operation of one s::can spectrometer V3 probe
- expand con::cube/con::lyte sensors networks (longer distances and higher number of sensors)
- RJ45 connector for wired network access
- spectrometer probe V3 communicates directly with your mobile device via WLAN
- optional: operation in flow cell

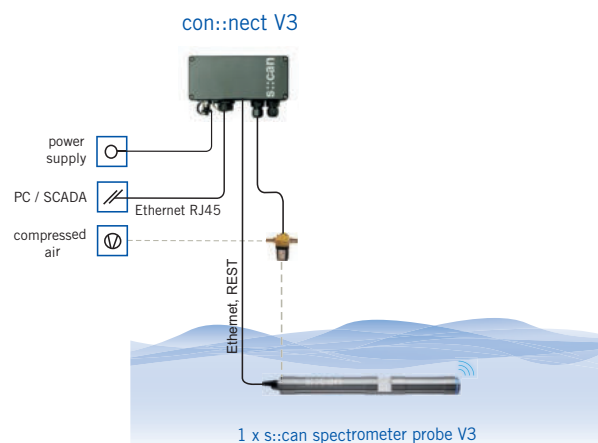

lo::Tool (WLAN remote connection)

visu::tool



Monitoring Stations

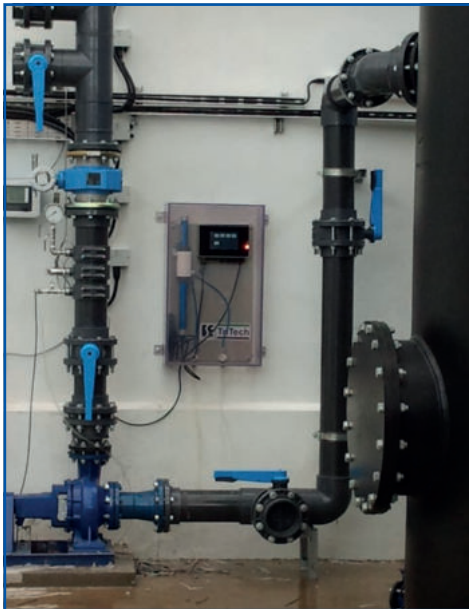

Process control in water treatment plant



Monitoring station

micro::station - Waste Water

- Spektrometer-sonden
- ISE-sonden
- Ionen-selektive Sonden
- Physikalische Sonden
- Bedienegeräte
- Software
- Systemkonfigurationen
- Messstationen
- Ersatzteile & Zubehör
- Services & Solutions

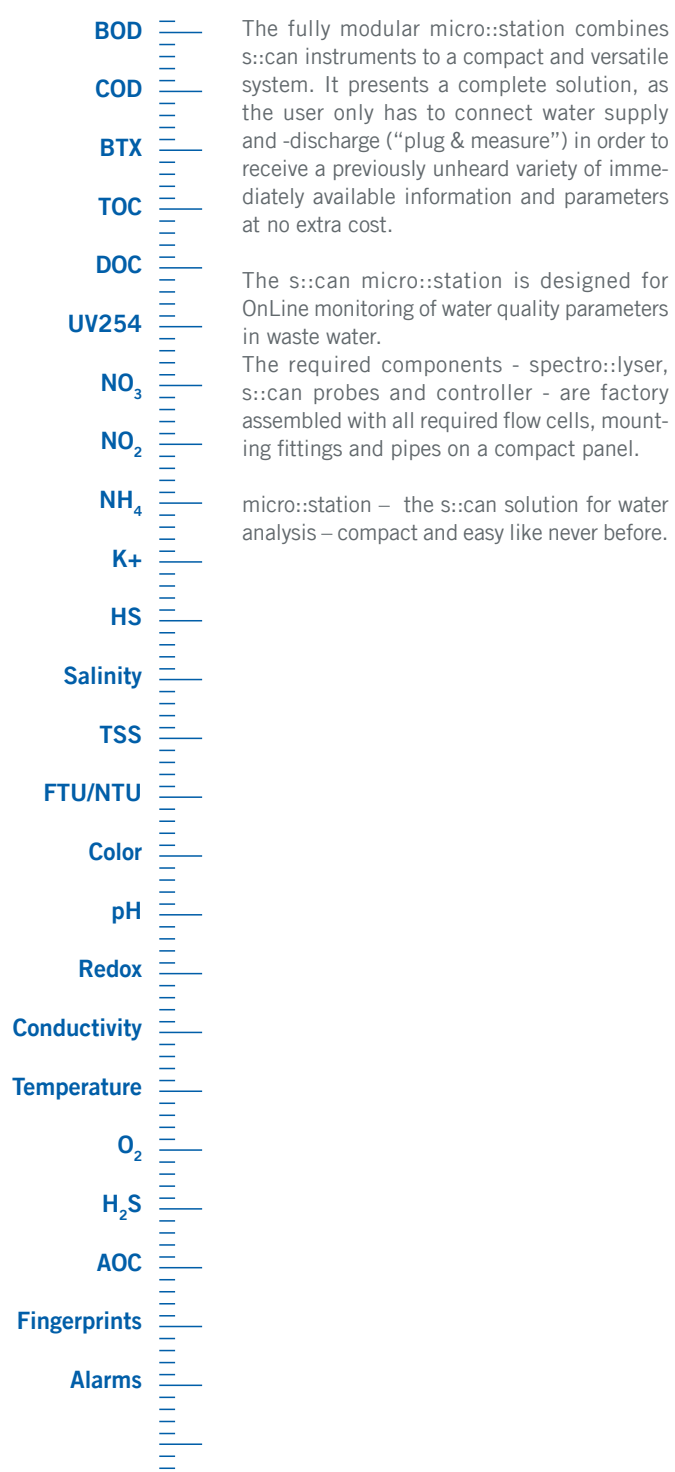

The fully modular micro::station combines s::can instruments to a compact and versatile system. It presents a complete solution, as the user only has to connect water supply and -discharge ("plug & measure") in order to receive a previously unheard variety of immediately available information and parameters at no extra cost.

The s::can micro::station is designed for OnLine monitoring of water quality parameters in waste water. The required components - spectro::lyser, s::can probes and controller - are factory assembled with all required flow cells, mounting fittings and pipes on a compact panel.

micro::station – the s::can solution for water analysis – compact and easy like never before.

1 Terminal
 con::cube terminal with moni::tool software for data acquisition, data display and station control

2 Spectrometer probe
 All s::can spectrometer probes are multi-parameter instruments that can measure a variety of water quality parameters
Possible parameters:
 AOC, BOD, BTX, COD, color, DOC, FTU/NTU, H₂S, HS, NO₂-N, NO₃-N, TOC, TSS, UV254, fingerprints and spectral alarms, temperature and pressure

3 Process connection
 Process connection 1", PVC

4 Flow cell for spectrometer probe
 s::can spectrometer flow-cell (PVC)

5 Flow cell for ISE probe or physical probe
 Flow cell for soli::lyser, oxi::lyser or s::can ISE probe (e.g. ammo::lyser)

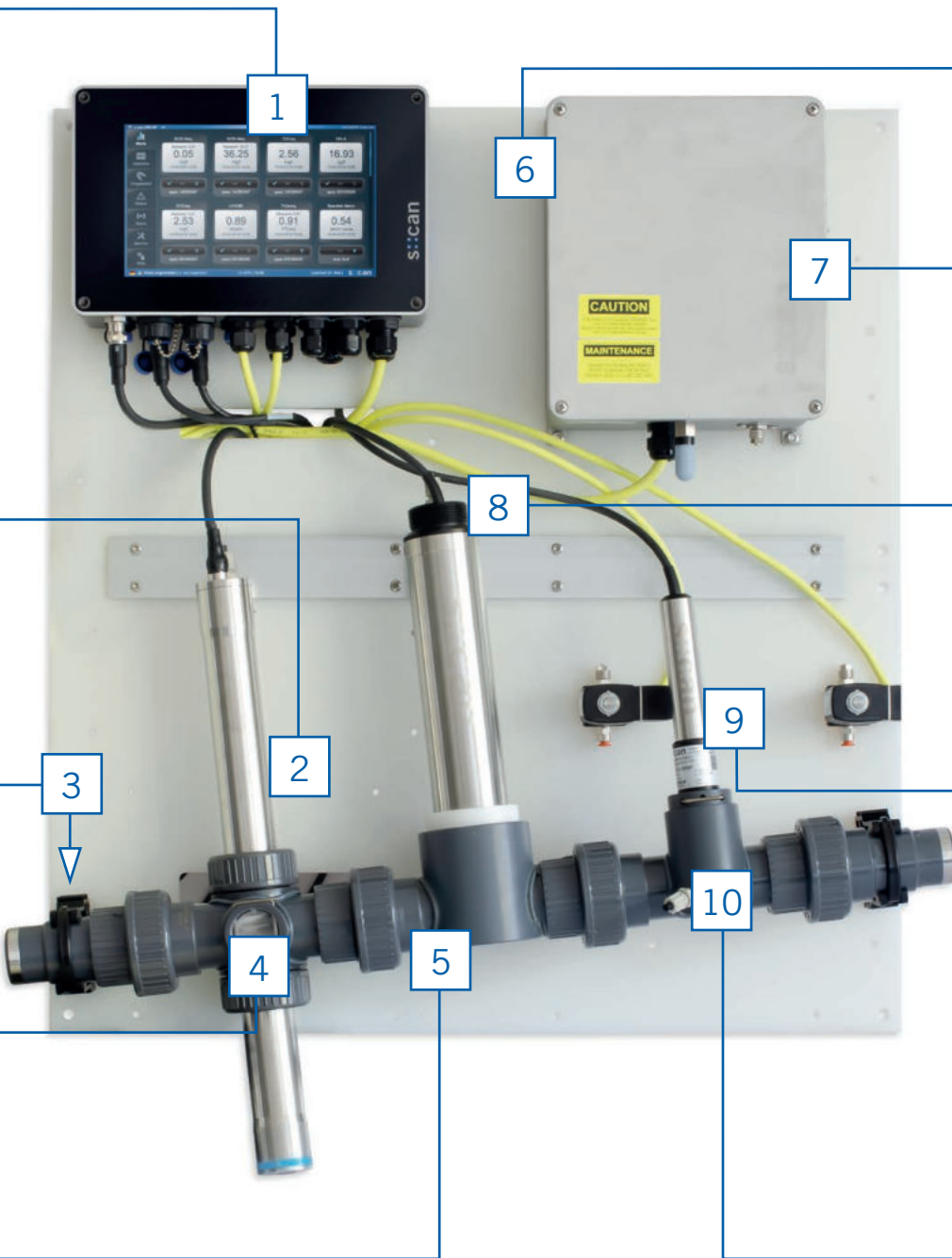

6 Main panel

Material: PP
 Weight of the station (fully equipped):
 25 kg (+/- 1 kg)

7 Compressor

Provides pressurized air for
 automatic cleaning

8 Physical probe or ISE probe

oxi::lyser, soli::lyser or one s::can
 ISE probe (e.g. ammo::lyser)
 can be installed here

Possible parameters:

K⁺, NH₄-N, NO₃-N, O₂, pH, TSS, and
 temperature

9 Physical probe

For installation of one s::can physical
 probe

Possible parameters:

pH, redox, salinity, conductivity and
 temperature

10 Flow cell for physical probe

s::can physical probe flow-cell (PVC)

micro::station - Waste Water

Options for s::can micro::station

1 Terminal	con::cube V3 con::lyte eco/pro
2 Spectrometer probe	spectro::lyser V3 carbo::lyser V3 multi::lyser V3 nitro::lyser V3 uv::lyser V3 spectro::lyser (UV) i::scan
3 Process connection	process connection 1", PVC
4 Flow cell for spectrometer probe	s::can spectrometer flow-cell (PVC)
5 Flow cell for ISE probe or physical probe	oxi::lyser or soli::lyser flow-cell (PVC) ammo::lyser flow-cell (PVC)
6 Main panel	
7 Compressor	s::can compressor 12 VDC or 110/230 VAC
8 Physical probe or ISE probe	ammo::lyser eco ammo::lyser pro fluor::lyser oxi::lyser soli::lyser
9 Physical probe	pH::lyser redo::lyser condu::lyser chlori::lyser
10 Flow cell for physical probe	s::can physical probe flow-cell (PVC)

- Spektrometer-sonden
- i::scan
- Ionenselektive Sonden
- Physikalische Sonden
- Bediengeräte
- Software
- Systemkonfigurationen
- Messstationen
- Ersatzteile & Zubehör
- Services & Solutions

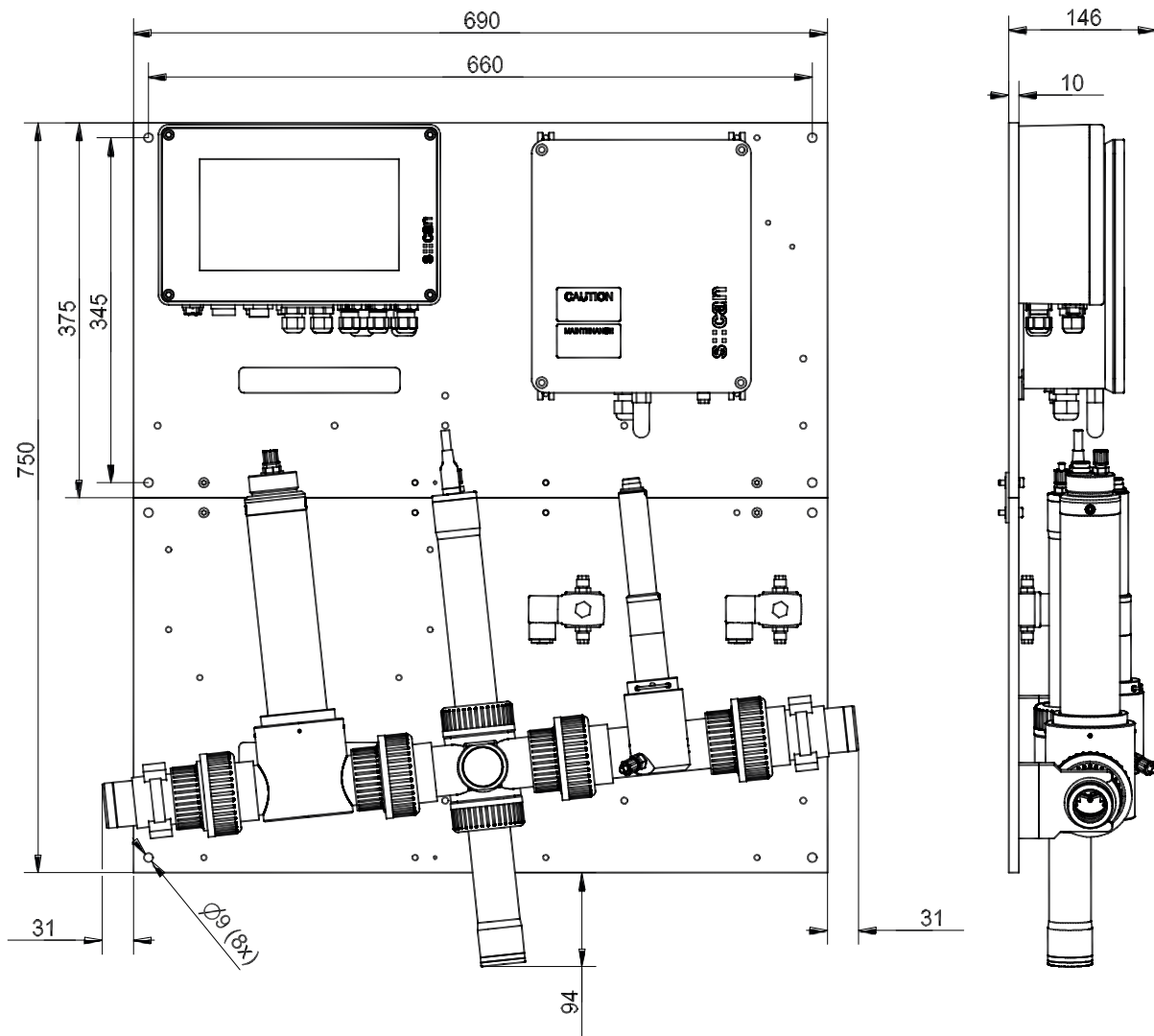

Spare Parts & Accessories



Reference electrode and ammonium electrode for ammonium



brush - brush for submerged installation

s::can compressor

- provides compressed air for s::can spectrometer probes, oxi::lyser, soli::lyser and ammo::lyser™
- removal of fouling using compressed air
- aluminium housing IP65 for wall mounting
- optional 12 VDC or 230/110 VAC version available
- railing-mounting set available

technical specification

power supply	type B32-230: 230 VAC type B32-110: 110 VAC type B32-012: 12 VDC
power consumption (typical)	AC 100 W DC 60 W (5.2A @ 12V)
power consumption (max.)	AC 100 W DC 180 W (15A @ 12V)
assembling	ex works
housing material	aluminium
dimensions (width x height x depth)	218 x 253 x 105 mm
weight (min.)	4.9 kg
process connection	1/4"
installation / mounting	Mounting bracket d6 / 0.25 dia
operating temperature	-10 ... 40 °C
operating pressure	0 ... 6 bar
ingress protection class	IP65
tank volume	0.4 l
charging time	typ. 25 sec
sound emission	60dB(A)
maintenance interval	1500 operating hours
storage temperature	-10 ... 60 °C
storage humidity	0 ... 95 %
conformity - EMC	EN 61326-1:2006
conformity - safety	EN 61010-1:2001
part number	B-32-230 B-32-110 B-32-012

to be used for

ammo::lyser™ pro
ammo::lyser™ eco
oxi::lyser™
spectro::lyser™ (UV)
carbo::lyser™ II / III - V3
multi::lyser™ IV - V3
nitro::lyser™ II - V3
ozo::lyser™ II - V3
uv::lyser™ V - V3

recommended accessories

part number	article name
B-44	cleaning valve
B-44-2	
C-31-eu	Optional 2 m power cable
C-31-us	Optional 2 m power cable

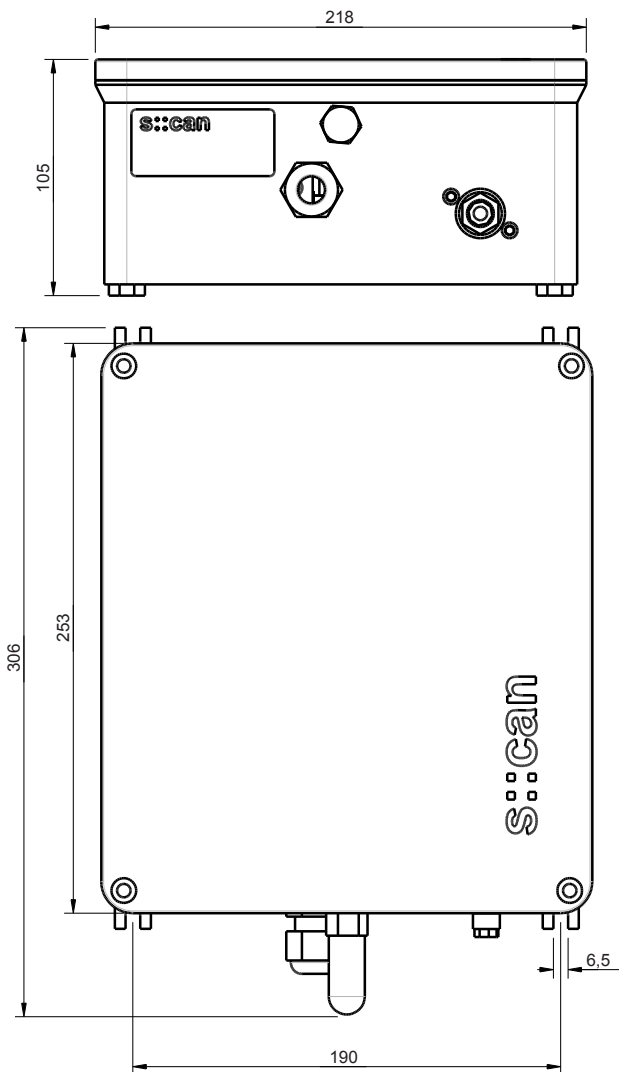

cleaning valve

- supports automatic cleaning of measuring elements of von s::can spectrometer probes, oxi::lyser, soli::lyser and ammo::lyser™
- removal of fouling, sediments and clogging using compressed air or -water
- version B-44-2 specially for use in combination with the s::can compressor

technical specification	
cable length	2.4 m (B-44) 1 m (B-44-2)
assembling	ex works
dimensions (width x height x depth)	85 x 75 x 70 mm
weight (min.)	500 g
process connection	B-44: pressure side DIN 7.2 coupling, at sensor direction ID 3/8" B-44-2: pressure side quick coupling d6x4, at sensor direction push-pull d6x4
ingress protection class	IP65
part number	B-44 B-44-2

recommended accessories	
part number	article name
B-41	s::can pressure connection set for V2 spectro::lyser and s::can sensors

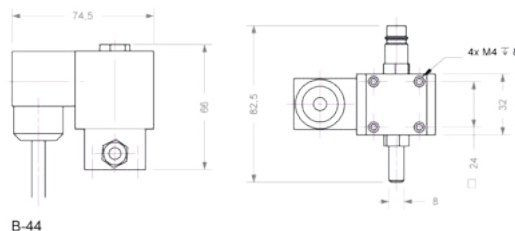

B-44

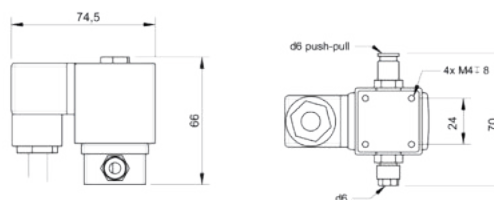

B-44-2

s::can flow-cell (by-pass setup), PVC (wastewater)

- side-by-side stackable flow cells for waste water applications (add-on dimension 177 mm)
- cleaning with pressurized air possible

technical specification	
housing material	PVC
dimensions (width x height x depth)	ammo::lyser: 117 x 83 x 108 mm i::scan: 177 x 83 x 90 mm oxi::lyser: 177 x 117 x 141 mm physical probe: 177 x 95 x 111 mm spectrometer probe: 177 x 98 x 126 mm
process connection	G 1" inner thread
recommended flow	< 40 l/min
part number	F-48-ammo F-48-iscan F-48-oxi F-48-sensor F-48-spectro



recommended accessories	
part number	article name
F-48-process	process connection 1", PVC

flow cell autobrush - for spectro::lyser V3 & V2 pathlength 35 mm

- for proper and easy flow-through installation of spectro::lyser probes
- for applications with frequent, automatic cleaning
- cleaning of optical windows with rotating brush without demounting of spectro::lyser probe

technical specification

power supply	12 VDC
assembling	ex works
housing material	POM-C
dimensions (width x height x depth)	74 x 132 x 153 mm
weight (min.)	1 kg
process connection	G 1/4"
installation / mounting	flow cell
operating temperature	0 ... 40 °C
operating pressure	0 ... 6 bar
ingress protection class	IP66
part number	F-446-1

to be used for

Spectrometer Probes



recommended accessories

part number	article name
F-501-eco-us	System Panel micro::station US
F-501-eco-eu	System Panel micro::station EU
F-45-process	process connection 1/4" G

i::scan flow cell for up to 3 additional spectro::lyser probes

- for proper and easy flow-through installation of one i::scan and up to three spectro::lyser physical probes
- automatic cleaning with autobrush for i::scan available (optional)

technical specification

housing material	POM-C
dimensions (Ø x l)	106 x 103
weight (min.)	1 kg (without autobrush)
process connection	G 1/4", hose nozzle 7mm
installation / mounting	flow cell
operating temperature	0 ... 50 °C
operating pressure	0 ... 6 bar
part number	F-46-four-iscan

to be used for

condu::lyser
 redo::lyser
 pH::lyser
 chlori::lyser (analog)
 i::scan



recommended accessories

part number	article name
F-501-eco-us	System Panel micro::station US
F-501-eco-eu	System Panel micro::station EU
F-45-process	process connection 1/4" G
F-45-strain	Inlet strainer

flow cell for four s::can physical probes

- for proper and easy flow-through installation of conductance, chloride, redox and pH probes
- for applications without automatic cleaning in drinking water

technical specification

housing material	POM-C
dimensions (Ø x l)	106 x 103
weight (min.)	1.05 kg
process connection	G 1/4", hose nozzle 7mm
installation / mounting	flow cell
operating temperature	0 ... 50 °C
operating pressure	0 ... 6 bar
part number	F-45-four

to be used for

conductance
redox
pH
chloride (analog)



ruck::sack

- submersible Autobrush for spectrometer probes and i:scan
- exchangeable brushes for spectrometer probe with path length 35, 15, 5 mm and i:scan 35 and 5 mm
- one basis module (motor unit) for all versions
- shelter protects the brush from clogging

technical specification

power supply	12 VDC
power consumption (typical)	150 mA (average)
power consumption (max.)	300 mA
cable length	8 m
housing material	POM-C
dimensions (width x height x depth)	182 x 46 x 36.5 mm
weight (min.)	750 g (incl. cable)
installation / mounting	submersed
operating pressure	0 ... 0.5 bar
ingress protection class	IP68
storage temperature	-20 ... 80 °C
storage humidity	0 ... 95 %
part number	F-146-rs-35, F-146-rs-15, F-146-rs-05, F-146-rs-iscan-35, F-146-rs-iscan-05

to be used for

Spectrometer Probes
i:scan



recommended accessories

part number	article name
F-146-brush-35	brush for ruck::sack 35 mm (spare part)
F-146-brush-15	brush for ruck::sack 15 mm (spare part)
F-146-brush-05	brush for ruck::sack 5 mm (spare part)

simple mounting for i::scan in-pipe installation

- for proper and easy in-pipe installation of one i::scan (for PE, PVC and PP pipes)

technical specification	
housing material	POM and PP (saddle clamp)
dimensions (width x height x depth)	156 x 175 x 98 mm
weight (min.)	600 g
process connection	pipe outside diameter 110 mm
part number	F-140-iscan

to be used for	
i::scan	



pressure mounting for i::scan in-pipe installation (i::scan removal under pressure)

- for proper and easy installation of one i::scan in a pressure pipe
- under pressure drilling of pipes possible (for PE, PVC, DCI, steel and AC pipes)
- the i::scan can be mounted and demounted under pressure without interruption of the water flow

technical specification	
housing material	stainless steel
dimensions (height)	550 mm (max.)
weight (min.)	5 kg
process connection	for DCI, steel and AC pipes: DN80 ... DN600 (others on request)
	for PE- and PVC-pipes: pipe outside diameter 75 ... 315 mm
operating pressure	0 ... 12 bar
part number	F-160-iscan

to be used for	
i::scan	



Spectrometer infrastructure

part number	article name
A-001-s	Inserts for optical pathlength 1 mm, stainless steel
A-002-s	Inserts for optical pathlength 2 mm, stainless steel
A-005-s	Inserts for optical pathlength 5 mm, stainless steel
A-015-s	Inserts for optical pathlength 15 mm, stainless steel
A-500-s	Inserts for optical pathlength 0.5 mm, stainless steel
A-005-q	Inserts for optical pathlength 5 mm, stainless steel, special quartz windows
A-015-q	Inserts for optical pathlength 15 mm, stainless steel, special quartz windows
A-035-s	Cleaning insert for optical pathlength 35 mm, stainless steel
E-421-2	Multifunctional slide for pathlength 100 mm
E-431-1-iscan	multifunctional slide i::scan 35 mm
E-431-2-iscan	multifunctional slide i::scan 5 mm
E-421-V3	Multifunctional slide (for spectrometer V3 & V2 pathlength 0,5 mm to 35 mm)
V3-logger	License fee for integrated data logger in spectro::lyser V3 or G::series V3

Sensors infrastructure

part number	article name
E-508-1/2-EL	Chlorine Dioxide electrolyte (spare part)
E-508-1/2-SET	Chlorine Dioxide membrane cap (spare part)
E-509-1/2-EL	Hydrogen Peroxide electrolyte (spare part)
E-509-1/2-SET	Hydrogen Peroxide membrane cap (spare part)
E-510-guard	Electrode protection shelter (spare part)
E-513-ORP	ORP & reference electrode for redo::lyser (spare part)
E-514-pH	pH & reference electrode for pH::lyser (spare part)
E-515-1/2-EL	Peracetic Acid electrolyte (spare part)
E-515-1/2-SET	Peracetic Acid membrane cap (spare part)
E-520-1/2-KIT	Free Chlorine electrolyte and membrane cap (spare parts)
E-525-1/2-KIT	Total Chlorine electrolyte and membrane cap (spare parts)
E-532-ise-K	potassium electrode for ammo::lyser™ (spare part, new)
E-534-ise-NH4	Ammonium electrode for ammo::lyser™ (spare part, new)
E-532-ise-N03	Nitrate electrode for ammo::lyser V1 (spare part, new)
E-532-ise-pH	pH electrode for ammo::lyser V1 (spare part, new)
E-532-ise-ref	reference electrode for ammo::lyser V1 (spare part, new)
E-532-tool	Tool for s::can ISE probes (spare part)
E-533-ise-Cl	Chloride electrode for ammo::lyser V2 (spare part, new)
E-533-ise-K	Potassium electrode for ammo::lyser V2 (spare part, new)
E-535-ise-NH4	Ammonium electrode for ammo::lyser V2 (spare part, new)
E-533-ise-N03	Nitrate electrode for ammo::lyser V2 (spare part, new)
E-533-ise-pH	pH electrode for ammo::lyser V2 (spare part, new)
E-533-ise-ref	Reference electrode for ammo::lyser V2 (spare part, new)
E-542-ise-F	Fluoride electrode for fluor::lyser V1 (spare part, new)
E-543-ise-F	Fluoride electrode for fluor::lyser V2 (spare part, new)
E-632-ise	Refurbishment of ionselective electrodes for s::can ISE probes
E-632-ise-K	Refurbished Potassium electrode for ammo::lyser V1 (spare part, refurbished)
E-634-ise-NH4	Refurbished Ammonium electrode for ammo::lyser V1 (spare part, refurbished)
E-632-ise-N03	Refurbished Nitrate electrode for ammo::lyser V1 (spare part, refurbished)
E-633-ise-K	Refurbished Potassium electrode for ammo::lyser V2 (spare part, refurbished)
E-635-ise-NH4	Refurbished Ammonium electrode for ammo::lyser V2 (spare part, refurbished)
E-633-ise-N03	Refurbished Nitrate electrode for ammo::lyser V2 (spare part, refurbished)

Cleaning & Pressure Devices

part number	article name
B-44	Cleaning valve
B-44-2	
B-32-230	s::can compressor
B-32-110	
B-32-012	
B-32-m-012	Motor unit for compressor (12 VDC)
B-32-m-110	Motor unit for compressor (110 VAC)
B-32-m-230	Motor unit for compressor
B-32-service	Service kit for s::can compressed air supply
B-41	s::can pressure connection set for V2 spectro::lyser and s::can sensors
B-43-2	10 x desiccant
B-45-V2	PVC clips (spare part for V2 spectro::lyser), set of 2
B-60-1	Cleaning brush for pathlength < 15 mm
B-60-2	Cleaning brush for pathlength < 2 mm
B-61-1	Cleaning agent

Cables & Power Supply	
part number	article name
C-220-V3	20 m extension cable for s::can spectrometer probe V3 (M12-plug, Ethernet, 12 VDC)
C-210-V3	10 m extension cable for s::can spectrometer probe V3 (M12-plug, Ethernet, 12 VDC)
C-32-MIL	Adapter cable to connect a V2 spectrometer (MIL) to V3 Terminal (M12)
C-32-V3	Adapter cable to connect a V3 spectrometer (M12) to V2 Terminal (MIL Plug)
C-1-010-sensor	1 m connection cable for s::can physical and ISE probes
C-210-sensor	10 m extension cable for s::can physical probes and s::can ISE probes
C-210-spectro	10 m extension cable for s::can™ spectrometer probes
C-220-sensor	20 m extension cable for s::can physical probes and s::can ISE probes
C-220-spectro	20 m extension cable for s::can™ spectrometer probes
C-230-sensor	30 m extension cable for s::can physical probes and s::can ISE probes
C-230-spectro	30 m extension cable for s::can™ spectrometer probes
C-31-eu	Optional 2 m power cable
C-31-us	Optional 2 m power cable
C-41-hub	Distribution box for additional sensors such as i::scan, sensors & ISE probes (3 x IP67 sys plug connections, RS485, 12 VDC) incl. C-1-010-sensor

Operation, Visualisation and Additional Interfaces	
part number	article name
D-315-3GLX	Worldwide 3D internet connection via Quad-band HSPA (up to 5.7 Mbps/21 Mbps)
D-303-LX	Linux Application Licence (obligatory to D-330)
D-315-antenna-plug	Internal antenna adapter cable and connector, option for con::cube
D-315-antenna-pro	External, high range antenna option for con::cube, incl. 10 m extension cable
D-315-in-mA	2 analogue inputs (input module), provides 2 analogue inputs (4-20mA) for integration of 3rd party readings
D-315-in-relay	2 digital inputs (input module), provides 2 digital IN (5-24V) for integration of 3rd party readings
D-315-out-mA	2 analogue outputs (output module), provides data transfer to PLC systems
D-315-out-profibus	provides Profibus DPV0 for data transfer to PLC systems
D-315-out-relay	4 digital outputs (output module), provides 4 configurable relay contacts 1A
D-315-out-SDI12	SDI 12 (output module), provides SDI 12 for data transfer to PLC systems
D-319-logger	Datalogger option for con::lyte
D-319-out-mA	2 x 4 - 20 mA (output module for con::lyte)
D-319-out-profibus	Profibus (output module for con::lyte)
D-320-out-mA	License for 3 analog outputs (4-20 mA) for con::lyte pro
D-320-PID	3 x PID control output for con::lyte D-320
D-320-out-modbus	Modbus (software license for con::lyte D-320)



Installation	
part number	article name
F-51	weather shield for s::can terminals
F-110-iscan	carrier i::scan, for easy horizontal attachment
F-110-V3	carrier s::can spectrometer V3 & V2 probe, 45°
F-11-oxi-ammo	carrier oxi::lyser / soli::lyser / s::can ISE probes
F-120-iscan	carrier i::scan, for easy vertical attachment
F-120-V3	carrier s::can spectrometer V3 & V2 probe, vertical attachment
F-12-sensor	carrier s::can physical probes
F-130-iscan	carrier i::scan, for easy 45° attachment
F-140-iscan	simple mounting for i::scan in-pipe installation
F-146-brush-05	brush for ruck::sack 5 mm (spare part)
F-146-brush-15	brush for ruck::sack 15 mm (spare part)
F-146-brush-35	brush for ruck::sack 35 mm (spare part)
F-146-brush-iscan-35	brush for ruck::sack 35 mm i::scan (spare part)
F-146-brush-iscan-05	brush for ruck::sack 5 mm i::scan (spare part)
F-146-retro-05	ruck::sack retrofitting set to 5 mm OPL
F-146-retro-15	ruck::sack retrofitting set to 15 mm OPL
F-146-retro-35	ruck::sack retrofitting set to 35 mm OPL
F-146-rs-35, F-146-rs-15, F-146-rs-05, F-146-rs-iscan-35, F-146-rs-iscan-05	ruck::sack
F-15	fixing adapter - stainless steel
F-160-iscan	In-pipe Hawle i::scan fixture (ideal for -000 i::scan version), i::scan removal under pressure, for DN 80-600 pipes, pipe saddle must be ordered separately!
F-445-2	flow cell - for pathlength 100 mm
F-446-V3	flow cell AutoBrush, POM-C (for spectrometer V3 & V2 pathlength 35 mm)
F-446-2	flow cell autobrush - for spectro::lyser™ pathlength 100 mm
F-446-brush	brush for flow-cell AutoBrush (spare part)
F-446-brush-iscan	brush for flow-cell AutoBrush i::scan (spare part)
F-446-m	brush unit for flow-cell AutoBrush (spare part)
F-446-m-iscan-dw	brush unit for flow-cell Auto-Brush i::scan
F-45-alarm	Flow detector unit
F-45-ammo	flow cell for ammo::lyser™
F-45-flow-1	Automatic flow control unit
F-45-four	flow cell for four s::can physical probes
F-45-oxi	flow cell for oxi::lyser™ and soli::lyser
F-45-process	process connection 1/4" G
F-45-sensor	flow cell for s::can sensor
F-45-strain	Inlet strainer
F-45-valve	Flow adjustment valve
F-46-four-iscan	i::scan flow cell for up to 3 additional s::can probes
F-46-iscan	i::scan flow-cell (by-pass setup), Pom-C, without cleaning
F-48-ammo	ammo::lyser flow-cell (by-pass setup), PVC
F-48-iscan	flow cell for i::scan (waste water), PVC
F-48-oxi	oxi::lyser or soli::lyser flow-cell (by-pass setup), PVC
F-48-process	process connection 1", PVC
F-48-sensor	s::can Sensor flow-cell (by-pass setup), PVC
F-48-V3	spectrometer V3 & V2 flow-cell (bypass setup), PVC
F-500-p	Pressure Sensor for micro::station
F-500-pump	Drinking water pump for micro::station
F-500-service-set	Service set for micro::station
F-501-eco-eu	System Panel micro::station EU
F-501-eco-us	System Panel micro::station US
F-502-eco-eu	System Panel micro::station add-on module EU
F-502-eco-us	System Panel micro::station add-on module US
F-506-panel-eu	System panel nano::station EU
F-506-panel-us	System panel nano::station US
F-508-panel	System panel waste water micro::station
F-160-SPSET-DKxxx	Hawle shut off pipe saddle DK75 - DK315, incl. saddle blade (for PE and PVC pipes)
F-160-SPSET-DNxxx	Hawle shut off pipe saddle DN80 - DK600, incl. saddle blade (for ductile iron pipes)
F-445-V3	Flow-cell (by-pass fitting), Pom-C (for spectrometer V3 & V2 pathlengths from 1 mm to 35 mm)
F-446-V3-ti	Flow-cell (by-pass fitting) AutoBrush, Pom-C (for spectrometer V3 & V2 pathlength 35 mm) titanium version
F-446-2	flow cell autobrush - for spectro::lyser™ pathlength 100 mm
F-110-V3	Carrier s::can spectrometer V3 & V2 probe, for easy 45 degree attachment
F-120-V3	Carrier s::can spectrometer V3 & V2 probe, for easy vertical attachment

Services & Solutions

s::can
Intelligent. Optical. Online.

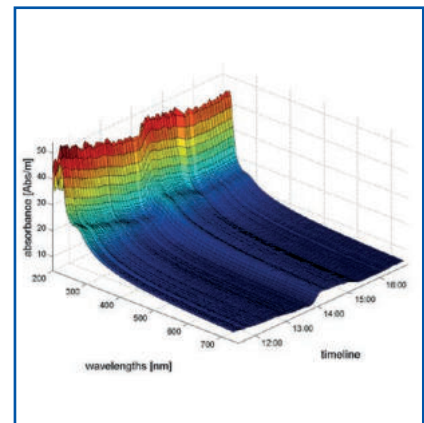

- Spectrometer Probes
- i::scan
- Ionselective Probes
- Physical Probes
- Terminals
- Software
- System Configuration
- Monitoring Stations
- Spare Parts & Accessories
- Services & Solutions

1 hour consulting, data handling

- 1 hour consulting, data handling

technical specification

part number	I-C
-------------	-----

1 hour service

- 1 hour service

technical specification

part number	I-S
-------------	-----

1 hour engineer, service on site

- 1 hour engineer, service on site

technical specification

part number	I-T
-------------	-----

start up deployment of one s::can monitoring system on site

- start up deployment of one s::can monitoring system on site

technical specification

part number	I-I
-------------	-----

feasibility study

- individual, substance specific spectral analysis by s::can Support
- prediction of substance-specific range & precision in distilled water
- considering possible background of solids
- recommendation of optical pathlength & possible standard applications, incl. scientific report
- no on-site sampling necessary
- background of solids required
- precondition for contamispac validation & parameter X

technical specification

part number	A-xf
-------------	------

parameter X1

- individual local calibration by s::can Support
- based on chemometric methods (PCA/PLS), incl. statement of statistical quality
- s::can feasibility study A-xf and validated laboratory results are precondition
- individual quotation from s::can Sales & individual clarification by s::can Support precondition

technical specification

part number	A-x1
-------------	------

assembly of s::can systems

- mounting of flow-cells on system panel
- mounting of terminals and additional components on system panel / weather shield
- wiring of autobrush / cleaning valve / pressure sensor / flow detector
- obligatory for s::can micro::station

technical specification

part number	X-sys-assy
-------------	------------

configuration of s::can systems

- initialisation of all s::can probes and initialisation of all parameters
- initialisation of autobrush / cleaning valve / pressure sensor / flow detector
- check of system configuration and test certificate

technical specification

part number	X-sys-config
-------------	--------------

3 years service spectro::lyser

- 3-year check and service of spectro::lyser incl. 3-year warranty extension

technical specification

part number	X-03-spectro
-------------	--------------

3 years service i::scan

- 3-year check and service of i::scan incl. 3-year warranty extension

technical specification

part number	X-03-iscan
-------------	------------

Sales Partners



- STATUS :: Headquarters, Representative Office, Affiliate
- STATUS :: Platinum Sales Partner
- STATUS :: Gold Sales Partner
- STATUS :: Silver Sales Partner

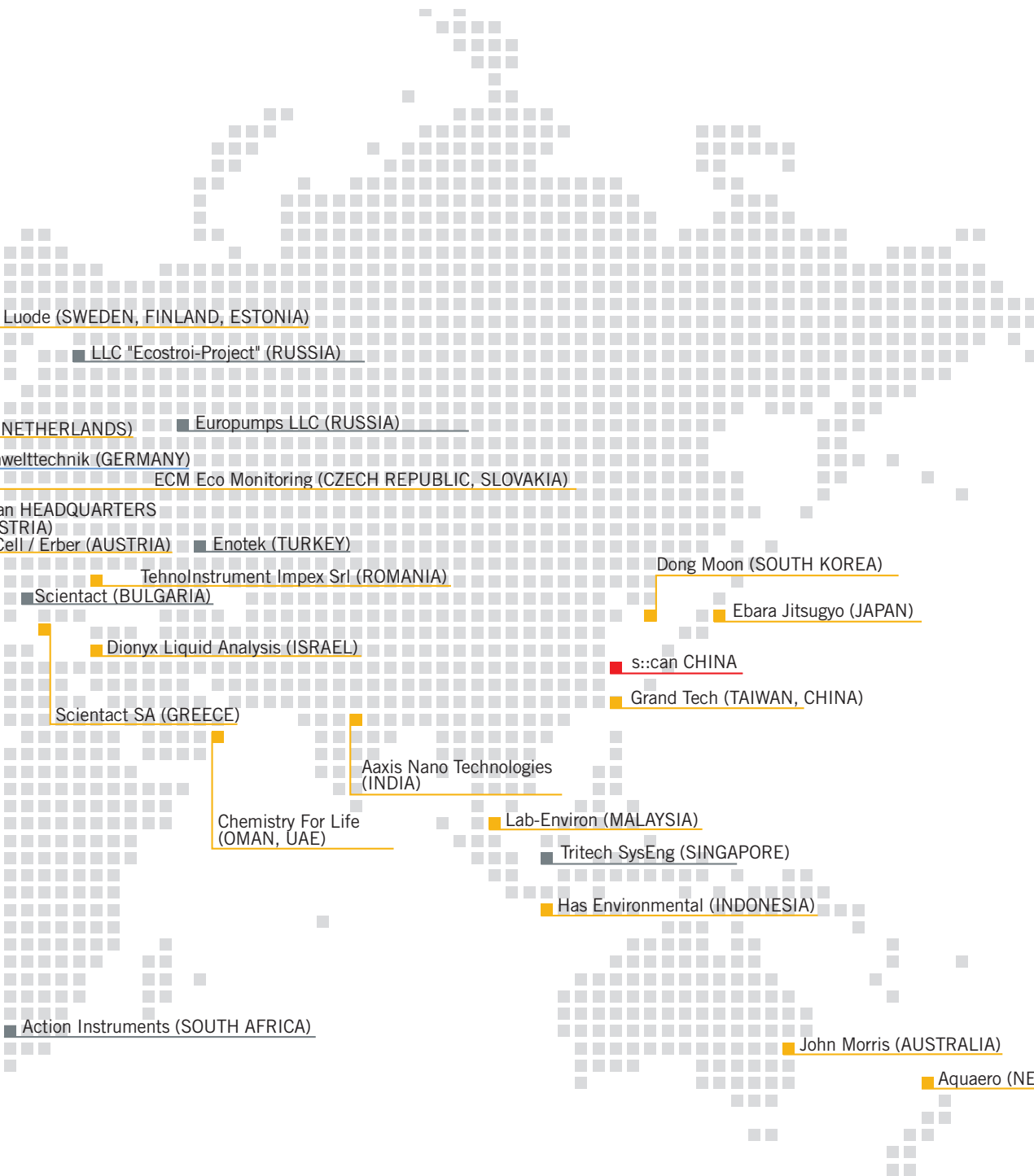

Luode (SWEDEN, FINLAND, ESTONIA)

■ LLC "Ecostroi-Project" (RUSSIA)

NETHERLANDS)

■ Europumps LLC (RUSSIA)

Umwelttechnik (GERMANY)

ECM Eco Monitoring (CZECH REPUBLIC, SLOVAKIA)

an HEADQUARTERS

STRIA)

Cell / Erber (AUSTRIA)

■ Enotek (TURKEY)

■ TehnInstrument Impex Srl (ROMANIA)

Dong Moon (SOUTH KOREA)

■ Scientact (BULGARIA)

■ Ebara Jitsugyo (JAPAN)

■ Dionyx Liquid Analysis (ISRAEL)

■ s::can CHINA

Scientact SA (GREECE)

■ Grand Tech (TAIWAN, CHINA)

Aaxis Nano Technologies (INDIA)

Chemistry For Life (OMAN, UAE)

■ Lab-Environ (MALAYSIA)

■ Tritech SysEng (SINGAPORE)

■ Has Environmental (INDONESIA)

■ Action Instruments (SOUTH AFRICA)

■ John Morris (AUSTRALIA)

■ Aquaero (NEW ZEALAND)

s::can Sales Partners

AT	HEADQUARTERS ADDRESS	s::can GmbH Brigittagasse 22-24 1200 Vienna, AUSTRIA	
	CONTACT PHONE	Mr. Robert Wurm +43 / 1 / 219 73 93	
	FAX	+43 / 1 / 219 73 93-12	
	EMAIL	sales@s-can.at	
	WEB	www.s-can.at	
CN	CHINA ADDRESS	s::can China Representative Office Rm D/17F Building B, 1118 Changshou Rd. 200042 Shanghai	
	CONTACT PHONE	Mr. Li Xiao (+86-21) 34060311	
	FAX	(+86-21) 34060311-811	
	EMAIL	lxiao@s-can.cn	
	WEB	www.s-can.cn	
	STATUS	Representative Office	
ES	SPAIN ADDRESS	s::can Iberia Sistemas de Medición S.L.U. Ciutat de Granda 28 bis, 1a planta 08005 Barcelona	
	CONTACT PHONE	Mr. Jordi Raich + 34 930 218 447	
	EMAIL	sales@s-can.es	
	WEB	www.s-can.at	
	STATUS	Affiliate	
FR	FRANCE ADDRESS	s::can France SARL 370 route de Saint Canadet 13100 Aix en Provence	
	CONTACT PHONE	Mr. Philippe Marinot + 33 (0) 4 42 20 35 01	
	FAX	+ 33 (0) 9 82 25 35 01	
	EMAIL	sales@s-can.fr	
	WEB	www.s-can.fr	
	STATUS	Affiliate	
IT	ITALY CONTACT	s::can in Italy Mr. Alessandro Morra +39 333 983 5634	
	PHONE	amorra@s-can.at	
	EMAIL	www.s-can.at	
	WEB	Regional Sales Manager	
	STATUS		
MX	MEXICO CONTACT	s::can in Mexico Efrain Hernández Reyes +52 (55) 4044 8729	
	PHONE	sales@s-can.mx	
	EMAIL	www.s-can.mx	
	WEB	Affiliate	
	STATUS		
PT	PORTUGAL CONTACT	s::can in Portugal Mr. Vincenzo Rocca +351 91 569 4663	
	PHONE	vrocca@s-can.at	
	EMAIL	www.s-can.at	
	WEB	Regional Sales Manager	
	STATUS		
US	USA ADDRESS	s::can Measuring Systems LLC 38C George Leven Drive North Attleboro, MA 02760	
	PHONE	+1 (888) 694-3230	
	FAX	+1 (888) 469-5402	
	EMAIL	sales@s-can.us	
	WEB	www.s-can.us	
	STATUS	Affiliate	
::	REST OF THE WORLD ADDRESS	s::can GmbH Brigittagasse 22-24 1200 Vienna	
	CONTACT PHONE	Mr. Robert Wurm +43 / 1 / 219 73 93	
	FAX	+43 / 1 / 219 73 93-12	
	EMAIL	sales@s-can.at	
	WEB	www.s-can.at	
	STATUS	Headquarter	
AE	UNITED ARAB EMIRATES ADDRESS:	Chemistry For Life Co. LLC	
	CONTACT PHONE	Amana Allah Ahli - Deira Al Murur - Dubai Mr. Xavier Craysac +971 4 321 82 20	
	FAX	+971 4 343 51 58	
	EMAIL	info@chemistry-for-life.com	
	WEB	http://www.chemistry-for-life.com	
	STATUS	Gold Sales Partner	
AT	AUSTRIA ADDRESS CONTACT	Erber Handel Linzer Straße 62, 3382 Loosdorf	
	PHONE	Mr. Raimund Erber +43 / 664 / 416 12 14	
	FAX	+43 / 2754 / 21 26	
	EMAIL	office@erber.co.at	
	WEB	www.erber.co.at	
	STATUS	Gold Sales Partner (East)	
AT	AUSTRIA ADDRESS	Cell GmbH Rummerweg 1, 5600 St. Johann im Pongau	
	PHONE	+43 / 6412 / 212 45	
	EMAIL	office@cell.cc	
	WEB	www.cell.cc	
	STATUS	Gold Sales Partner (West)	
AU	AUSTRALIA ADDRESS	John Morris Group 61-63 Victoria Avenue, Chatswood, NSW 2067	
	PHONE	+61 (02) 9496 4200	
	EMAIL	info@johnmorrisgroup.com	
	WEB	https://www.johnmorrisgroup.com	
	STATUS	Gold Sales Partner	
BE	BELGIUM ADDRESS CONTACT	Elscolab n.V. Hogenakkerhoekstraat 14, 9150 Kruikebe	
	PHONE	Mr. Dirk Vleminckx +32 / 3 / 250 15 70	
	FAX	+32 / 3 / 252 87 83	
	EMAIL	elscolab@elscolab.com	
	WEB	www.elscolab.com	
	STATUS	Gold Sales Partner	
BG	BULGARIA ADDRESS	Scientact BG LTD 46, Prof. Kiril Popov Str, 1734 Sofia, Studentski Grad	
	CONTACT PHONE	Mr. Dimitris Kouvas +359 24 68 48 67	
	MOBILE	+359 89 36 15 770 - 71	
	EMAIL	bg@scientact.com	
	WEB	www.scientact.com	
	STATUS	Silver Sales Partner	
CA	CANADA ADDRESS	Arrow Technology Group 11432 215 Street (Winterburn Rd.), T5S 2Y3, Edmonton, Alberta	
	CONTACT PHONE	Lyndon Lobo +1 / 780 / 701 40 50	
	FAX	+1 / 780 / 239 83 19	
	EMAIL	lyndon@atg.net	
	WEB	www.atg.net	
	STATUS	Silver Sales Partner	
CA	CANADA ADDRESS	Aquatic Life Ltd. 34 Alexander Avenue ROE 1L0 Pinawa, MB	
	CONTACT PHONE	Mr. Jeff Simpson +1 / 204 / 753 52 70	
	FAX	+1 / 204 / 753 20 82	
	EMAIL	aquatic@aquaticlife.ca	
	WEB	www.aquaticlife.ca	
	STATUS	Gold Sales Partner	

- STATUS :: Headquarters, Representative Office Affiliate
- STATUS :: Platinum Sales Partner
- STATUS :: Gold Sales Partner
- STATUS :: Silver Sales Partner

CH	SWITZERLAND ADDRESS CONTACT PHONE FAX EMAIL WEB STATUS	Uniqtech /Unimon GmbH Vorbühlstrasse 21, CH-8962 Bergdietikon Ms. Martina Hofer + 41 43 444 95 56 + 41 43 444 95 86 info@unimon.ch www.unimon.ch Gold Sales Partner	GR	GREECE ADDRESS CONTACT PHONE FAX EMAIL WEB STATUS	Scientact SA 16 Kanari St., 55644 Thessaloniki Mr. Dimitris Kouvas +30 / 2310 / 946 126 +30 / 2310 / 947 005 dgk@scientact.com.gr http://www.scientact.com.gr Silver Sales Partner
CL	CHILE ADDRESS CONTACT PHONE FAX EMAIL WEB STATUS	Carlos Rivas Padilla y Cia. Ltda Escanilla 1176, Independencia, Santiago de Chile Mr. Carlos Rivas +56 / 2 / 2688 2010 +56 / 2 / 2688 2010 info@rilab.cl www.rilab.cl Silver Sales Partner	ID	INDONESIA ADDRESS: PHONE FAX EMAIL WEB STATUS	Has Environmental Ruko Mega Cempaka Mas Blok i No.12, Jl. Letjend Soeprapto – Jakarta Pusat +62 21 429 0000-7 +62 21 426 4624 info@has-environmental.com www.has-environmental.com Gold Sales Partner
CO	COLOMBIA ADDRESS CONTACT PHONE FAX EMAIL WEB STATUS	B&C Biosciences Ltda. Cra. 19 No. 58A, 75 Bogota Mr. Jaime Wilson Velandia +57 / 1 / 349 04 75 +57 / 1 / 349 04 78 byc@bycenlinea.com www.bycenlinea.com Silver Sales Partner	IN	INDIA ADDRESS: CONTACT PHONE FAX EMAIL WEB STATUS	Aaxis Nano Technologies SCF 78, 2nd Floor, Phase 2, SAS Nagar District Mohali, State Punjab, 160055 Mr. Sanjeev Gogia +91 / 172 / 5098279 +91 / 9216745369 info@aaxisnano.com www.aaxisnano.com Gold Sales Partner
CR	COSTA RICA ADDRESS CONTACT PHONE FAX EMAIL WEB STATUS	Innovagua SA 100 m Norte de Prousa, Diagonal AyA, Ipis, Goicoechea, 10805 San José Mr. Kenneth Mena +506 / 2245 0269 +506 / 2245 0270 ventas@innovagua.com www.innovagua.com Silver Sales Partner	IL	ISRAEL ADDRESS: CONTACT PHONE EMAIL WEB STATUS	Dionyx Liquid Analysis Ltd. Hasadna 13 Street 4365006 Ra'anana Mr. Leon Foror +972 9 886 6052 leon@dionyx.co.il www.dionyx.co.il Gold Sales Partner
CZ	CZ CZECH REPUBLIK ADDRESS CONTACT PHONE FAX EMAIL WEB STATUS	ECM ECO Monitoring, s. r. o Dobrá 240 73951 Dobrá Mr. Peter Smitek +420 / 558 / 60 17 27 +420 / 558 / 60 17 20 ecmdobra@ecomonitoring.cz www.ecomonitoring.cz Silver Sales Partner	IT	ITALY ADDRESS: CONTACT PHONE FAX EMAIL WEB STATUS	Isoil Industria spa Via F.lli Gracchi, 27 20092 Cinisello Balsamo MI Mr. Roberto Vesprini +39 02 660 272 38 +39 02 660 272 88 vendite@isoil.it www.isoil.it Gold Sales Partner
DE	GERMANY ADDRESS CONTACT PHONE FAX EMAIL WEB STATUS	GWU-Umwelttechnik GmbH Bonner Ring 9 50374 Erftstadt Mr. Philipp Clemens +49 / 2235 / 955 22-0 +49 / 2235 / 955 22-99 wasser@gwu-group.de www.gwu-group.de Platinum Sales Partner	JP	JAPAN ADDRESS: CONTACT PHONE FAX EMAIL WEB STATUS	Ebara Jitsugyo Co. Ltd. Environmental Measuring Instrument Technology Center 2-3-12 Kurigi, Asao-ku, Kawasaki-shi, 215-0033 Kanagawa Mr. Masahiro Kanai +81 / 44 / 981 05 60 +81 / 44 / 981 05 61 kanai@ejk.co.jp www.ejk.co.jp Gold Sales Partner
FI	FINLAND ADDRESS CONTACT PHONE FAX EMAIL WEB STATUS	Luode Consulting Sinimaentie 10 B 02630 Espoo Mr. Mikko Kiirikki +358 / 40 / 867 83 66 - mikko.kiirikki@luode.net www.luode.net Gold Sales Partner	KR	KOREA ADDRESS CONTACT PHONE FAX EMAIL WEB STATUS	Dong Moon ENT Co., Ltd #501, #503-#505, Woolim e-Biz Center II, 12, Digital-ro 33-gil , Guro-gu, Seoul, 08377 Mr. Song Yo Ill +82 / 2 / 890 35 91 +82 / 2 / 890 35 90 dongmoonent@naver.com http://www.dongmoonent.co.kr Gold Sales Partner
GB	UNITED KINGDOM ADDRESS: CONTACT PHONE FAX EMAIL WEB STATUS	PMA, Process Measurement & Analysis Ltd. Brook Mills House, Carr Lane, Slaithwaite, Huddersfield, West Yorkshire HD7 5BQ Mr. Chris Bristow +44 / 1484 / 84 37 08 +44 / 1483 / 84 36 89 sales@processmeasurement.uk.com www.processmeasurement.uk.com Gold Sales Partner	MY	MALAYSIA ADDRESS CONTACT PHONE FAX EMAIL WEB STATUS	Lab-Environ Instruments Sdn Bhd C-3A-6, Kuchai Exchange, No. 43 Jalan Kuchai Maju 13 58200 Kuala Lumpur Mr. Range Lee Kwong Leng +60 / 3 / 798 434 58 +60 / 3 / 798 317 44 sales@lab-environ.com www.lab-environ.com Gold Sales Partner

NL	NETHERLANDS ADDRESS CONTACT PHONE EMAIL WEB STATUS	Qsenz B.V. Maricoweg 15A 1791 MD - Den Burg - Texel Mr. Ewout Riteco +31 / 222 76 00 16 ewout.riteco@qsenz.nl www.qsenz.nl Gold Sales Partner	SG	SINGAPORE ADDRESS PHONE FAX EMAIL WEB STATUS	Tritech SysEng PTE Ltd. 31 Changi South Avenue 2, Tritech Building +65 62 87 57 10 +65 62 87 08 93 syseng@singnet.com.sg www.syseng.com.sg Silver Sales Partner
NO	NORWAY ADDRESS: CONTACT PHONE FAX EMAIL WEB STATUS	Pemac AS Barstølveien 50F, P.O. Box 9038 4696 Kristiansand Mr. Hallgeir Hallsteinsen +47 / 38 / 05 61 00 +47 / 38 / 05 61 00 hallgeir@pemac.no www.pemac.no Gold Sales Partner	SK	SLOVAKIA ADDRESS: CONTACT PHONE FAX EMAIL WEB STATUS	ECM ECO Monitoring, a. s. Nevádzová 5 82101 Bratislava Mr. Michal Ruzicka +421 / 2 / 43 42 94 17 +421 / 2 / 43 42 74 65 ecm@ecm.sk www.ecomonitoring.com Gold Sales Partner
NZ	NEW ZEALAND ADDRESS: CONTACT PHONE EMAIL WEB STATUS	Aquaero New Zealand Ltd 129 Shackleton Road, Mount Eden Auckland Mr. Tara Okan +64 21 2233920 tara@Aquaero.co.nz https://www.linkedin.com/company/aquaero-new-zealand/ Gold Sales Partner	TR	TURKEY ADDRESS CONTACT PHONE FAX EMAIL WEB STATUS	Enotek Müh. ve Danismanlik Hiz. Ltd. Sti. Fulya Mah., Şenol Sok. Feride İş Merkezi No:3 D:5, 34394 Şişli/İstanbul / Turkey Su Atıksu Takımı +90 / 212 28 812 58 +90 / 212 27 558 93 suatıksu@enotek.com.tr www.enotek.com.tr Silver Sales Partner
OM	OMAN ADDRESS: CONTACT PHONE EMAIL WEB STATUS	Chemistry For Life Co. LLC Ghala Industrial Area, P.O BOX 1393 133 Muscat Mr. Xavier Craysac +968 / 990 / 423 70 xavierc@chemistry-for-life.com http://www.chemistry-for-life.com Gold Sales Partner	TW	TAIWAN, CHINA ADDRESS: CONTACT PHONE FAX EMAIL WEB STATUS	Grand Tech (T.F.) Co., Ltd. 18F.-2, No. 157, Section 2, Wenhua 2nd Road, Linkou District, New Taipei City 244 Mr. Kuan-Yi Ke +886 / 2 / 86 01 36 63 +886 / 2 / 86 01 36 65 grand-tech@grand-tech.com.tw www.grand-tech.com.tw Gold Sales Partner
PT	PORTUGAL ADDRESS: CONTACT PHONE FAX EMAIL WEB STATUS	Zeben – Sistemas Electrónicos Lda. Travessa de Baixo, nº5, 4935-571 Castelo do Neiva, Viana do Castelo Mr. Adélio Neto +351 253 818 850 +351 253 818 851 geral@waterfix.pt www.waterfix.pt Silver Sales Partner	ZA	SOUTH AFRICA ADDRESS CONTACT PHONE FAX EMAIL WEB STATUS	Action Instruments SA CC 7th Floor Everite House, 20 de Korte Street, Braamfontein 2001 Johannesburg Mr. Peter Fleming +27 / 11 / 403 22 47 +27 / 11 / 403 02 87 info@aisa.co.za www.aisa.co.za Silver Sales Partner
RO	ROMANIA ADDRESS CONTACT PHONE EMAIL WEB STATUS	TehnoInstrument Impex Srl Laboratorului Street, no. 31B 100301 Ploiesti jud. Prahova Mr. Sebastian Codescu +40 722 559 754 office@tehnoinstrument.ro www.tehnoinstrument.ro Gold Sales Partner			
RU	RUSSIA ADDRESS PHONE EMAIL WEB STATUS	LLC „Ecostroi-Project“ 34, Yelizarova Ave., Büro 301, 192148 St. Petersburg +7 / 812 / 333 41 18 l.prokhorenko@europumps.ru ecostroipro.ru Silver Sales Partner			
RU	RUSSIA ADDRESS CONTACT PHONE EMAIL WEB STATUS	Europumps LLC Naya st., 70, BC Zhulebino, 9f 09431 Moscow Mr. Leonid Prokhorenko +7 495 782-3083, add. 133 l.prokhorenko@europumps.ru www.europumps.ru/ Silver Sales Partner			
SE	SWEDEN ADDRESS CONTACT PHONE EMAIL WEB STATUS	Luode Consulting Ronnebyvägen 2, 12152 Johanneshov Mr. Niklas Strömbeck +46 / 70 / 850 96 69 niklas.strombeck@luode.net www.luode.net Gold Sales Partner			

abbreviation list

est	estimated
f	filtered
eq	equivalent
color app	color apparent
color tru	color true (filtered)

s::can

Intelligent. Optical. Online.

All units are in millimeter.

Subject to misprint or typographical errors.

We worked with greatest accuracy though data can be outdated.

We do not take any liability for content and data.

© s::can GmbH

Release: October 2020

HEADQUARTERS

s::can GmbH
Brigittagasse 22-24
1200 Vienna, AUSTRIA
T: +43 / 1 / 219 73 93
F: +43 / 1 / 219 73 93-12
sales@s-can.at
www.s-can.at

CHINA

Rm D /17F Building B
1118 Changshou Rd.
200042 Shanghai
T: (+86-21) 34 06 03 11
F: (+86-21) 34 06 03 11
lxiao@s-can.cn
www.s-can.cn
Status: Representative Office

FRANCE

s::can France SARL
370 route de Saint Canadet
13100 Aix en Provence
P: + 33 4 42 20 35 01
F: + 33 9 82 25 35 01
sales@s-can.fr
www.s-can.fr
Status: Affiliate

ITALY

s::can Contact Italien
Alessandro Morra
T: +39 333 983 5634
amorra@s-can.at
Status: Regional Sales Manager

MEXICO

s::can Mexico Sistemas de
Medición S. de R.L. de C.V
sales@s-can.mx
www.s-can.mx
Status: Affiliate

PORTUGAL

s::can Contact Portugal
Vincenzo Rocca
T: +351 91 569 4663
vrocca@s-can.at
Status: Regional Sales Manager

SPAIN

s::can Iberia Sistemas de Medi-
ción S.L.U.
Ciutat de Granada 28 bis,
1a Planta, 08005 Barcelona
P: +34 930 218 447
sales@s-can.es
www.s-can.es
Status: Affiliate

USA

s::can Measuring Systems LLC
38C George Leven Drive
North Attleboro, MA 02760
T: +1 (888) 694-3230
F: +1 (888) 469-5402
sales@s-can.us
www.s-can.us
Status: Affiliate

